



Entro-V Controls

Part No: 90001308/90001299
BASIC CONTROLLER, DIGITAL CONTROLLER AND OTHER
CONTROL OPTIONS
User and installation manual



Contents

PART I – GENERAL DEFINITIONS	4
1. General Information	4
1.1. Introduction.....	4
1.2. Functions	5
1.3. Product Description & Code	7
2. Control Board	8
2.1. Control board technical information	8
2.2. Control board input / output.....	8
2.3. Control board alternatives	12
2.3.1. PWM control & TERMINAL connection (90001522)	12
2.3.2. PWM control & SOCKET connection (90001315)	14
3. Controllers	16
3.1. Basic Controller (90001308).....	16
3.1.1. Button	16
3.1.2. LEDs.....	17
3.1.3. Cable connection	17
3.1.4. Surface mounting	18
3.2. Digital Controller (90001299)	19
3.2.1. Buttons	19
3.2.2. Screenshots	20
3.2.3. Cable connection	25
3.2.4. Surface mounting	26
4. Accessories	27
4.1. Sensors	27
4.1.1. Temperature Sensor (90001316).....	27
4.1.2. Humidity Sensor (90001322)	27
4.1.3. Carbon dioxide (CO ₂) Sensor (90001319).....	28
4.1.5. Pressure transmitter.....	28
PART II – WORKING SCENARIO.....	29
1. Fan Speed Control.....	29
2. Boost Function	29
3. Filter Control	30
4. By-Pass & Rotor Control	30
4.1. By-Pass Control	30
4.2. Rotor Control	30
5. Heating & Cooling Control.....	31

5.1. Electric Heater Control [HT]	31
5.2. Water Coil Control [CW].....	31
5.3. Heating-Cooling System with Refrigerant (DX System) [DX].....	32
6. Frost Protection [FRZ]	32
7. Room Temperature Sensor Function [T_RO].....	32
8. BMS Function	33
8.1. External on/off control [BMS].....	33
8.2. Status info (Run out) [RUN].....	33
8.3. Fault info (Fault out) [FLT].....	33
9. Modbus Function.....	33
9.1. Properties	33
9.2. Connection	34
9.3. Modbus Function.....	34
9.4. Modbus Register List.....	35
10. Timer Function.....	36
11. Fire Scenario [FRE]	37
12. Child Proof Protection Function	37
13. Unit Status When Power On.....	37
PART III – ALARM (Failure)	38
1. Fault Info (Fault out) [FLT].....	38
2. Fault Code List.....	38
ANNEX.A – SERVICE OPERATIONS	40
1. Basic Controller	40
2. Digital Controller	40
4. Register List.....	43

Abbreviations & Acronyms

AI	: Analogue Input	FRE	: Fire info (DI)
AO	: Analogue output	FRZ	: Heat recovery frost protection scenario
BMS	: Unit run function (dry contact) (DI)	FWV	: DX system 4-way valve (DO)
BST	: "Boost" function (DI)	HT	: Heater
BYP	: By-Pass damper (DO)	HT1	: Heater 1 st stage (DO)
C_OA	: Fresh air fan counter input (CI)	HT2	: Heater 2 nd stage (DO)
C_RA	: Exhaust fan counter input (CI)	HT3	: Heater 3 rd stage (DO)
CI	: Counter input	HTI	: Heater fault info (DI)
CW	: Water coil	PH	: Pre-heater
CWI	: Water coil failure (freezing) info (DI)	PH1	: Pre-heater 1 st stage (DO)
CWO	: Water coil (DO)	PH2	: Pre-heater 2 nd stage (DO)
DI	: Digital input	PO	: Power output
DO	: Digital output	RF	: Wireless with RF
DX	: DX System (Heating-Cooling System with refrigerant)	RTR	: Rotor (DO)
DX1	: DX system 1 st stage (DO)	RUN	: Unit run info (DO)
DX2	: DX system 2 nd stage (DO)	SDI	: Service door info (DI)
DXH	: DX system refrigerant high-pressure info (DI)	SE1	: Sensor 1 (AI)
DXI	: DX system failure (DI)	SE2	: Sensor 2 (AI)
DXL	: DX system refrigerant low-pressure info (DI)	SEA	: Season info (DO)
F_OA	: Fresh air fan	T_OA	: Outdoor air temperature
F_RA	: Exhaust air fan	T_PA	: Controller temperature
FDF	: DX system frost protection scenario	T_RA	: Return air temperature
FI1	: Mechanical filter pollution system 1 (DI)	T_RO	: Room temperature
FI2	: Mechanical filter pollution system 2 (DI)	T_SA	: Supply air temperature
FLT	: Unit fault info (DO)	T_UV	: UV lamp fault info
		UVL	: UV lamp (DO)

PART I – GENERAL DEFINITIONS

1. General Information

1.1. Introduction

Lately, most of our life is spent indoors (at home, office, etc) and indoor air quality has become a very important topic. To help reducing the indoor air pollution, heat recovery units have been designed. Mechanical Ventilation with Heat Recovery (MVHR) ensures that the stale air is extracted from the indoor environment, heat is recovered within the plate heat exchanger, and fresh filtered air is supplied indoors being warmed-up within the heat recovery core at a requested temperature. Many design building projects include heat recovery units being requested by the users. The biggest challenge in using these units is the control system. The main difference between basic heating-cooling systems (fan-coil, duct type fan, duct type indoor units, etc.) and ventilation units is that the ventilation units have two fans to control (supply and extract fans). Both fans must be controlled separately in various operating conditions. For instance, in some cases it may be requested to keep the ventilated environment to a positive pressure (supply only) or a negative pressure (extraction only). In this case, it is required to set both fans at different speeds or one fan on and the other fan off. Also, it is possible to adjust the ventilation amount automatically depending on the amount of CO₂ or moisture in these units, which leads to saving energy, thanks to the on-demand ventilation. In addition, according to the latest building regulations, the summer by-pass function is a requirement (the fresh air is bypassing the plate heat exchanger, being supplied indoors directly). Thanks to the HRU Controller developed by our company, all functions and safety requirements expected from a heat recovery unit can be met. Different working scenarios have been created for customer's demands and control of different ancillaries to be used with the units.

Please read the important safety information before starting any work included in this guide.



Before proceeding with any wiring work, make sure the unit and any unit ancillaries are disconnected from the mains power.

Electrical supply to the unit should be isolated before completing any wiring, maintenance or repair work.

Any work on the unit apart from basic maintenance should be carried out by a suitably qualified person.



1.2. Functions

Function	Definition
Fan Speed Control	<p>It provides control of the speed of fans.</p> <ul style="list-style-type: none"> • Manual: 3 steps fan speed control for EC or AC fans <ul style="list-style-type: none"> ○ Single fan mod ○ Individual speed control of the fans • Automatic <ul style="list-style-type: none"> ○ With sensors (Humidity, CO₂, etc.) ○ Constant volume or Constant pressure
Boost Function	<p>It is used for increasing fan speed if necessary</p> <ul style="list-style-type: none"> • Manual: Boost button on Control controller • Dry contact on control board
Filter Function	<p>It warns the user when the filters are dirty.</p> <ul style="list-style-type: none"> • Alternative-1: Depend on time • Alternative-2: Pressure switch mechanically
By-Pass Function	<p>Filtered fresh air is supplied indoor without passing in heat exchanger.</p>
Rotor Function	<p>It controls the motor of the rotor on/off in the ventilation units with rotor type heat recovery exchanger.</p>
Electric Heater Control Function	<p>Electric post heater steps control.</p>
Water Coil Control Function	<p>Water type Cooling or Heating/Cooling coil control.</p>
Sensor Function <ul style="list-style-type: none"> ○ Humidity sensor ○ CO₂ sensor ○ Air quality ○ Constant flow ○ Constant pressure 	<p>It provides automatic speed control of device fans for different usage conditions.</p> <ul style="list-style-type: none"> • Speed control according to the air <ul style="list-style-type: none"> ○ With the humidity sensor, the amount of humidity in the indoor air is measured, and at high humidity values, the fan speed is increased and the humidity is discharged. ○ With the CO₂ sensor, the amount of CO₂ in the indoor air is measured, and by increasing the fan speed at high CO₂ values, more fresh air is taken into the room, increasing the amount of O₂ and decreasing the amount of CO₂. ○ With the Air Quality sensor, the amount of particles and various gases in the indoor air are measured and the quality of the ambient air is increased by increasing the fan speed in response to the rise in any of them. • Stable working condition <ul style="list-style-type: none"> ○ Constant flow function; It allows the device to operate at a certain air flow rate. There may be changes in the air flow, especially depending on the amount of pollution in the filter. Thanks to this feature, the device will always work with the air flow rate set. ○ Constant pressure function; It is used to adjust the air flow in the system, especially in VAV uses.
Refrigerant Heating-Cooling System Control Function (DX System)	<p>It controls the heat recovery unit with heat pump refrigerant system (DX system). Equipment such as compressor and 4-way valve are controlled. For the safety of the DX system, gas high pressure, gas low pressure, compressor gas outlet temperature and condenser frost protection are controlled.</p>
Frost Protection Function	<p>Heat exchanger frost protection</p> <ul style="list-style-type: none"> • Alternative-1: By-Pass damper • Alternative-2: Fan speed control • Alternative-3: Electric Preheater steps control

Function	Definition
Preheater Function	Electric preheater steps control for frost protection.
Room Temperature Function	Enables selection of return air temperature or control controller temperature as room temperature.
BMS Function	It allows simple control of the unit from a central control system and monitoring of the situation. <ul style="list-style-type: none"> • BMS: Unit can be on/off via dry contact on control board • Run out: Information of "unit status" • Fault out: Information of "fault"
Modbus Function	It controls all functions of unit via PC or central control system.
Timer Function ¹	Unit can be programmed to operate on certain periods of the week.
Log Function ¹	All possible working options of the unit can be recorded.
Fire Function	It is used for changing working status of the unit in case of fire.
Service Door	Thanks to a mechanical switch placed in the service door; When the service door is opened, the device is stopped, thus preventing the service personnel from being damaged by the mechanical parts.
Child-Proof Protection Function	It is used to lock the key on control controller (keylock). <ul style="list-style-type: none"> • Alternative-1: Manually • Alternative-2: Automatically
Wireless Control	It provides the connection of wireless (RF) control controller and wireless room sensors to the unit.
IoT Function	It allows the features of the unit to be followed over the internet.
Service Interface	The unit provides adjustment of all operating parameters and functions.

¹ Works in "Digital Controller" and "Touch Controller".

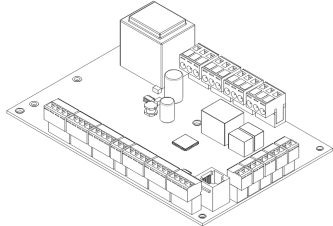
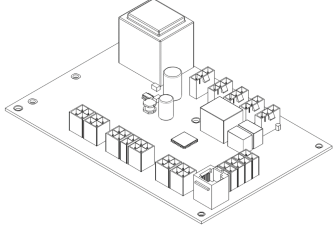
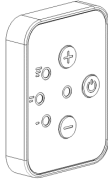
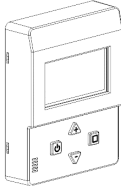
1.3. Product Description & Code

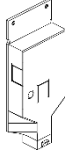
Code	Description	Equipment view
90001522	Control board PWM control & Terminal connection (Part I – Section 2.3.1)	
90001315	Control board PWM control & Socket connection (Part I – Section 2.3.2)	
90001308	Basic controller (Part I – Section 3.1)	
90001299	Digital controller (Part I – Section 3.2)	
90001316	Temperature sensor (Part I – Section 4.1.1)	
90001322	Humidity sensor (Part I – Section 4.1.2)	
90001319	Carbon dioxide (CO ₂) sensor (Part I – Section 4.1.3)	

2. Control Board

2.1. Control board technical information

Power supply	: 230V AC \pm 15%, 50 ~ 60Hz
Power consumption	: 5W (max)
Working condition	: 0 ~ 50°C, %90RH (max) (no condensation)
Storage condition	: -20 ~ 70°C
Electrical protection class	: IP20

2.2. Control board input / output

There are 21 I/O ports on the Control Card. These; 2 analogue outputs, 5 analogue inputs, 2 digital outputs (dry contact), 5 power outputs and 5 digital inputs (dry contact). Also, 7 I/O are assigned to a fixed task, other I/Os are adjustable according to the structure of the device and user demands. More details can be found in the table below.

I/O	Code	Status	Description
AO	FAN_OA PWM	Fixed	Fresh air fan PWM out
	FAN_RA PWM	Fixed	Exhaust air fan PWM out
CI	FAN_OA "tacho"	Fixed	Fresh air fan alarm input (counter input)
	FAN_RA "tacho"	Fixed	Exhaust air fan alarm input (counter input)
AI	TER_OA	Fixed	Outdoor air temperature sensor input
	TER_RA	Fixed	Return air temperature sensor input
	TER_SA	Fixed	Supply air temperature sensor input
	SE1	Register 185	Sensor input
	SE2	Register 186	Sensor input
DO	DO1	Register 157	Default: Run info [RUN]
	DO2	Register 158	Default: Fault info [FLT]
PO	LP0	Register 159	Default: By-Pass [BYP]
	LP1	Register 160	Default: Electric heater 1 st stage [HT1]
	LP2	Register 161	Default: Electric heater 2 nd stage [HT2]
	LP3	Register 162	Default: Electric preheater 1 st stage [PH1]
	LP4	Register 163	Default: Rotor [RTR]
DI	DI-1	Register 170	Default: Boost input [BST]
	DI-2	Register 171	Default: BMS in [BMS]
	DI-3	Register 172	Default: Fire alarm input [FRE]
	DI-4	Register 173	Default: Heater failure info input [HTI]
	DI-5	Register 174	Default: Filter alarm input [FIL]

AI : Analogue input
 AO : Analogue output
 CI : Counter input
 DI : Digital input
 DO : Digital output
 PO : Power output (230V)

2.3. Control board alternatives

2.3.1. PWM control & TERMINAL connection (90001522)

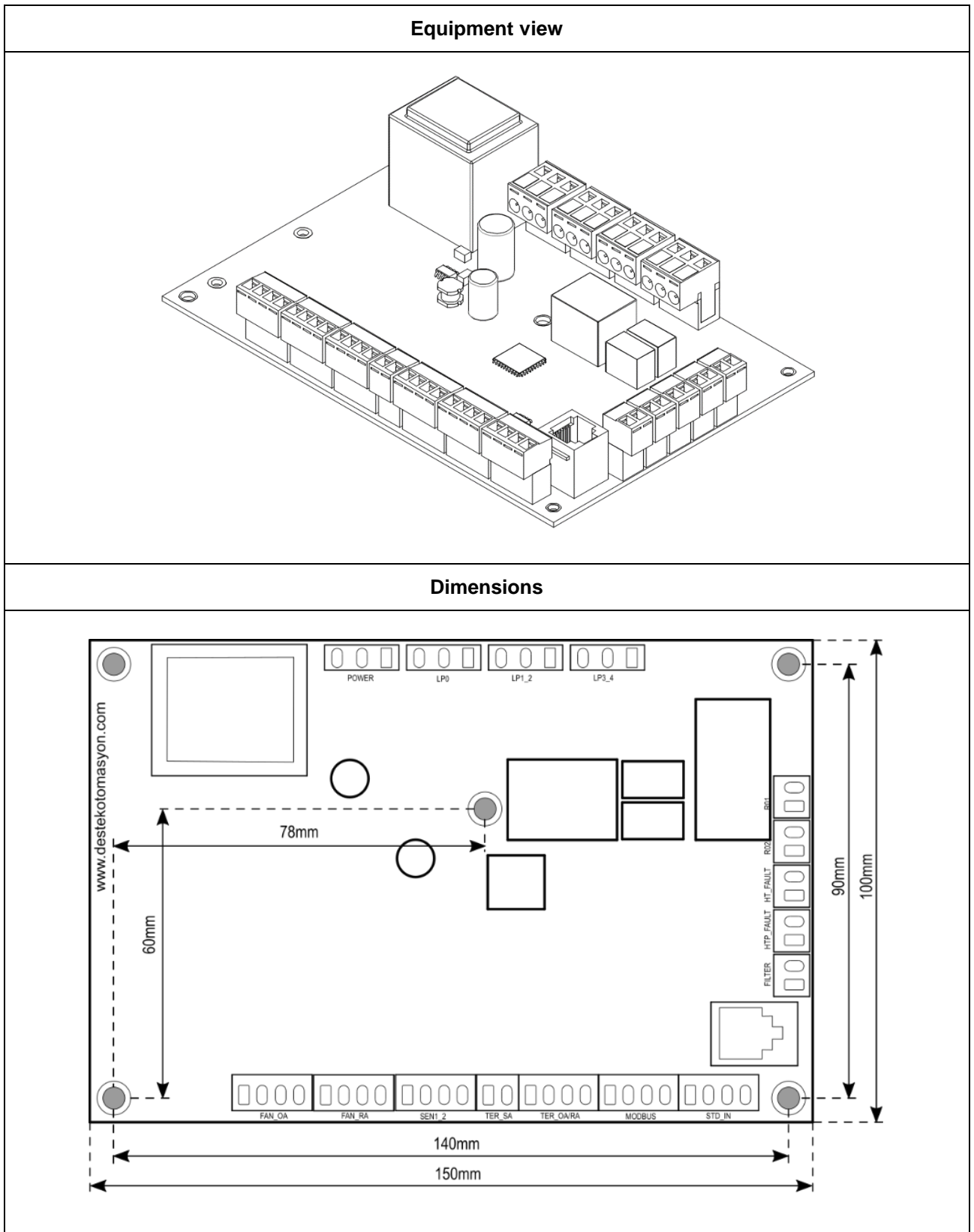

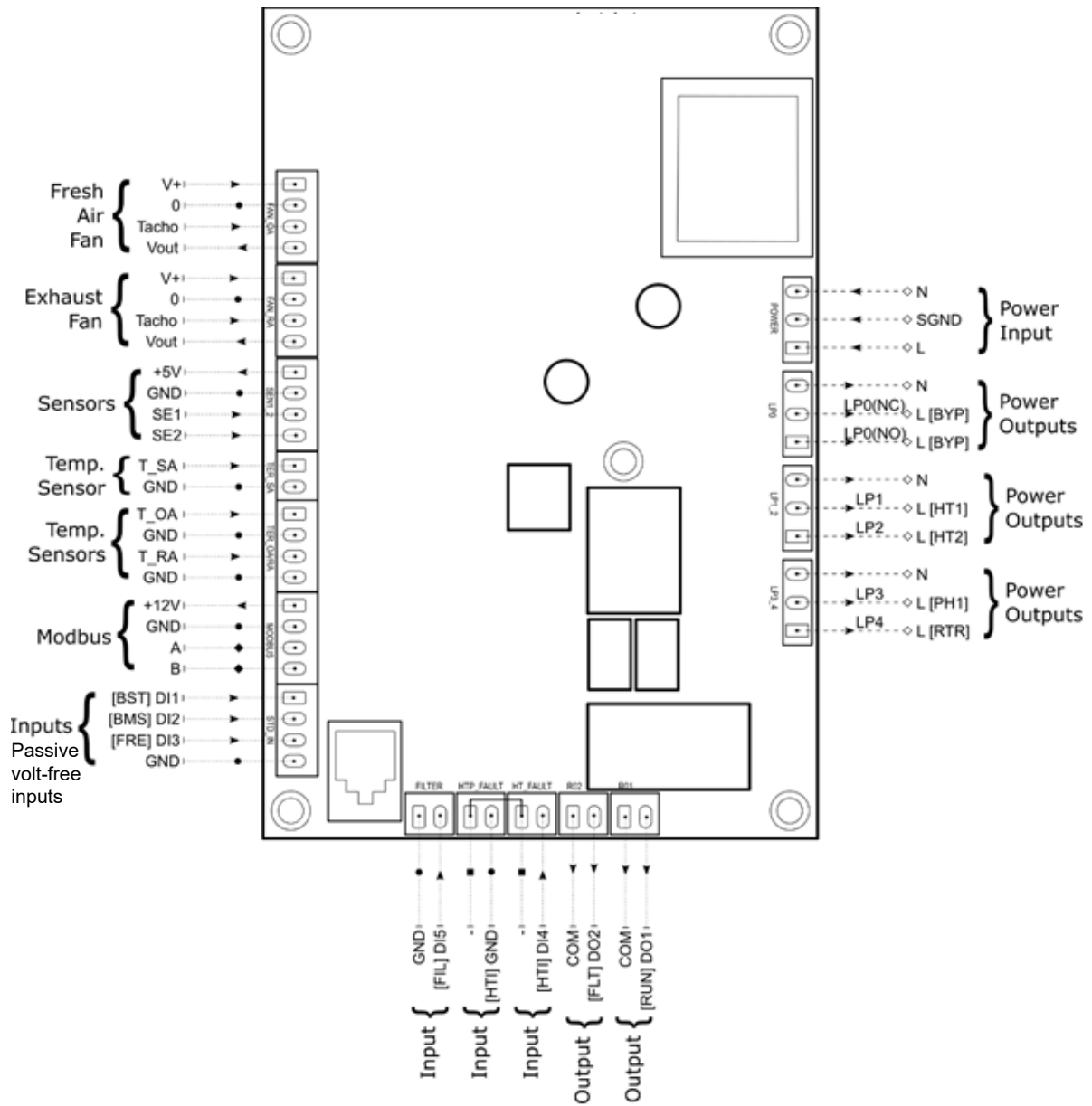

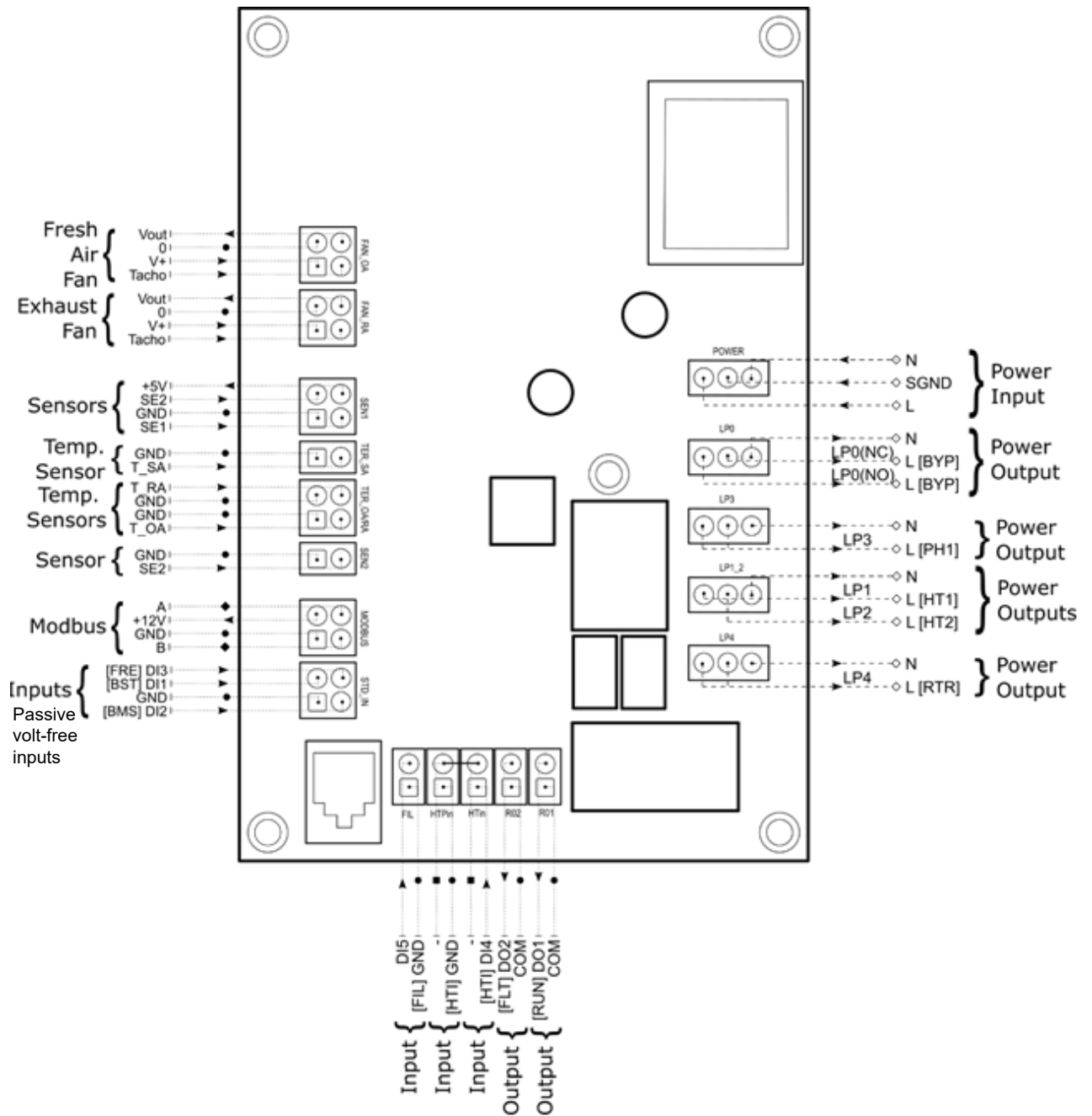

3. Controllers

3.1. Basic Controller (90001308)

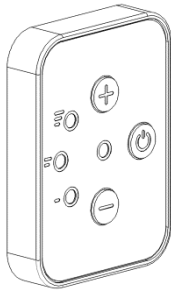

The Basic Controller was designed to allow the user to simply control all the basic functions of the unit. There are 3 basic buttons and 4 LEDs on it.

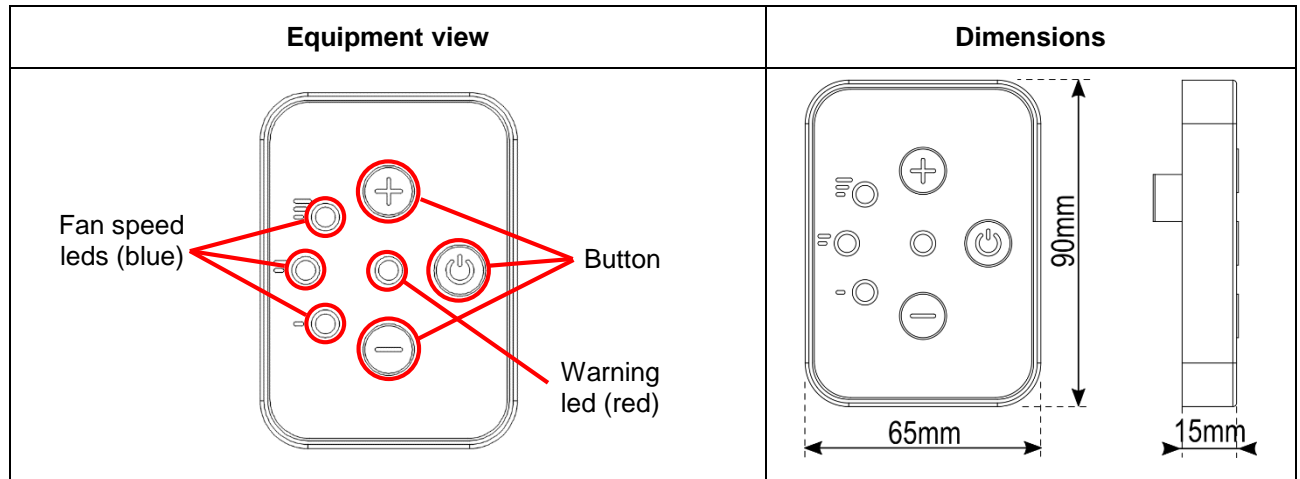

3.1.1. Button

Function	Button	Activity
Unit Start / Stop ¹		Press for 3 seconds
To increase fan speed		Press
To decrease fan speed		Press
To activate "boost" function ²		Press
To reset the unit ³		Press for 3 seconds
To reset the duration of filter contamination depending time ⁴		Press for 3 seconds
To activate VOD mod ⁵	 or 	Press for 3 seconds
Child lock		Press for 3 seconds

¹ Cannot open or close if BMS ([Part II – Section 8.1](#)) is active

² Cannot change the fan speed if "Boost" function is active

³ Reset works if the unit is off

⁴ Cannot work if the unit has filter sensor

⁵ If the VOD mode is active and sensor connected

3.1.2. LEDs

H	M	L	!	Description
○	○	○	○	Unit powered off
●	○	○	○	Fan speed is "high".
○	●	○	○	Fan speed is "med".
○	○	●	○	Fan speed is "low".
●	●	●	○	Fan speed is "boost".
●	○	●	○	VOD mode is active.
⦿	⦿	⦿	⦿	Fire function is active.
○	○	○	⦿	Failure warning (see Part III).

○ Led is off ● Led is on ⦿ Blink

3.1.3. Cable connection

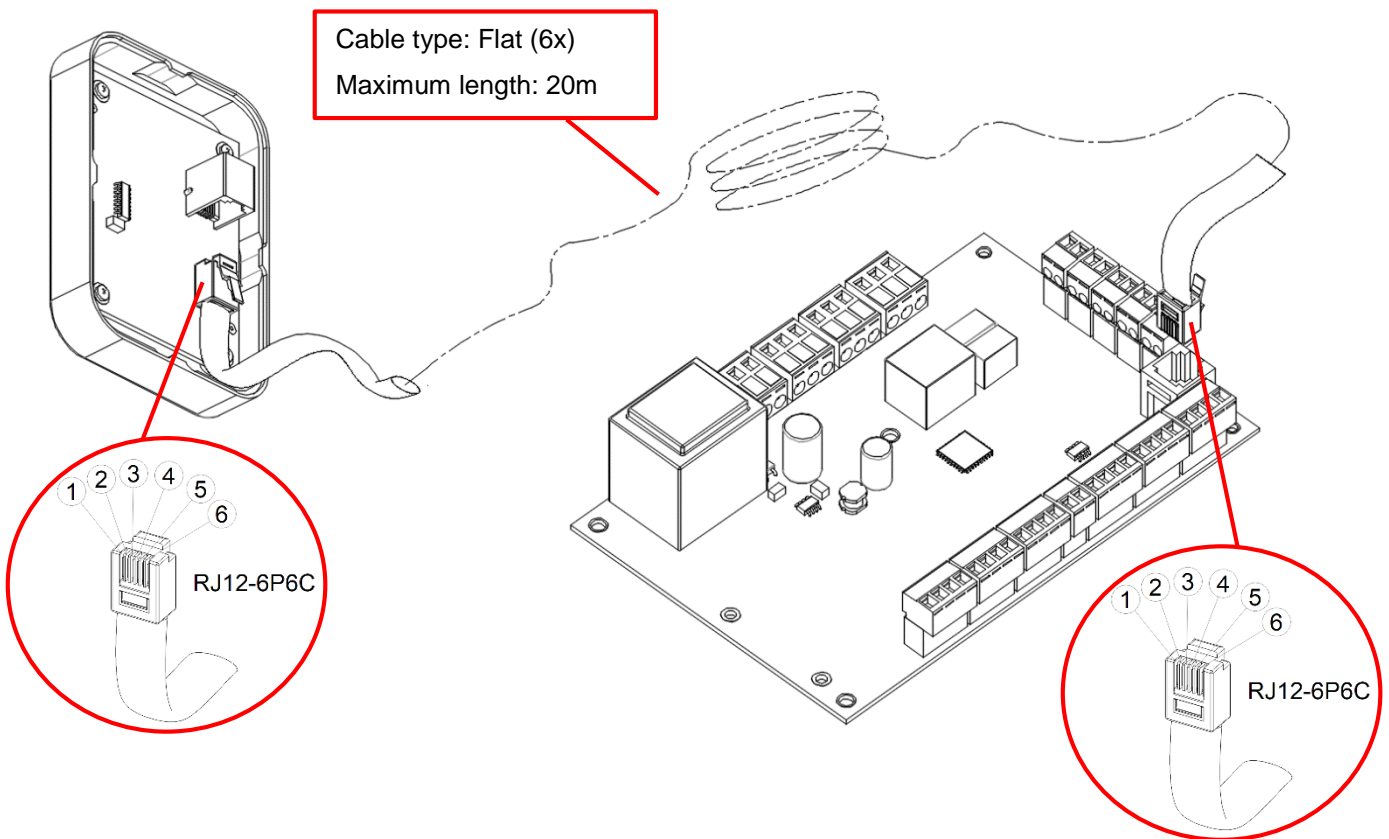

3.1.4. Surface mounting

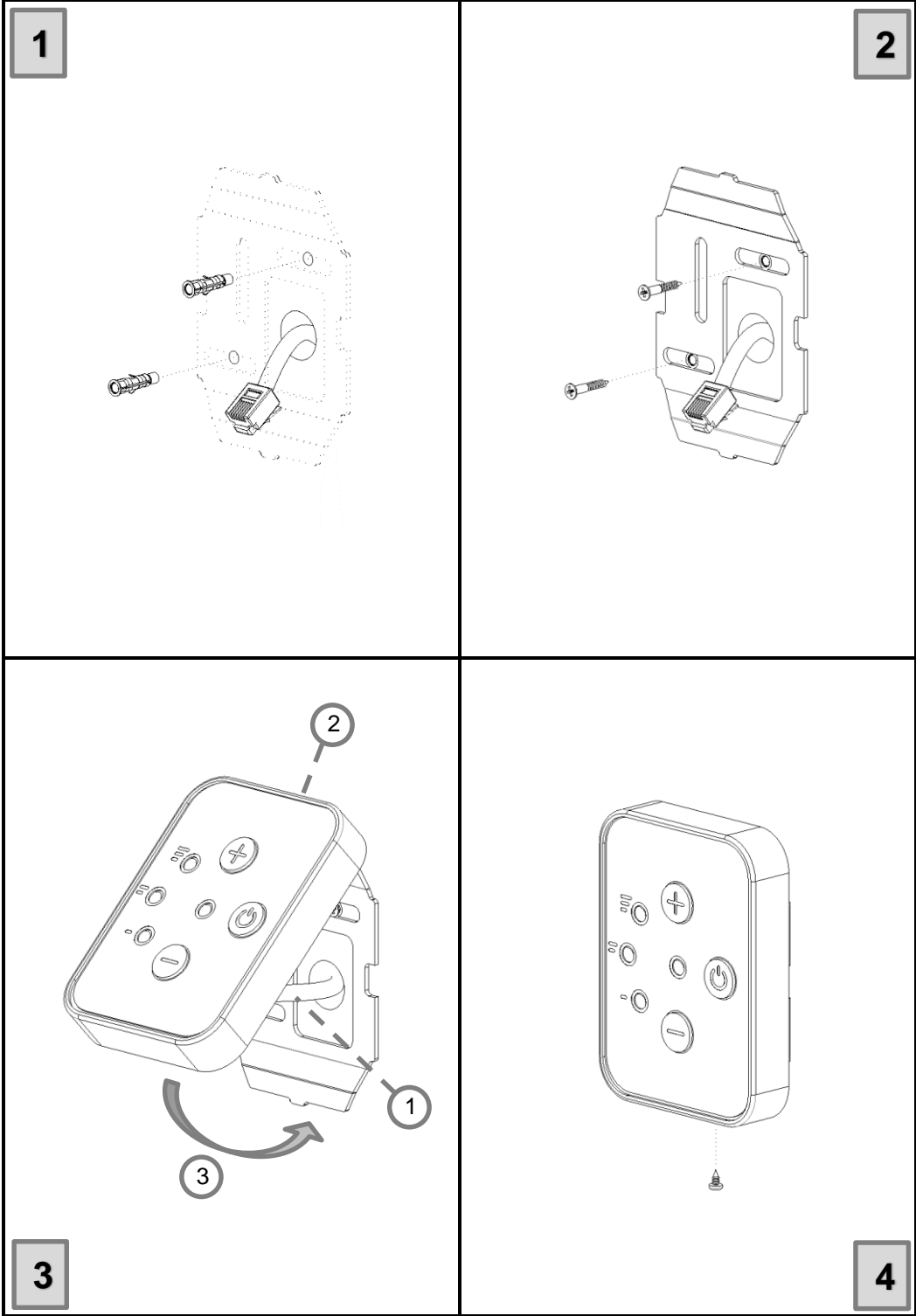

3.2. Digital Controller (90001299)

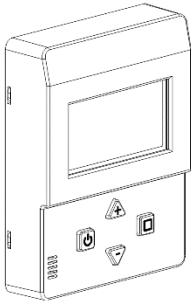

The Digital Controller was designed to control all the functions of the unit and to change settings related to the unit. It has 4 buttons and 1 graphic display.

Equipment view	Dimensions

3.2.1. Buttons

Function	Button	Activity
Unit Start / Stop ¹		Press for 3 seconds
To switch to screens in between. (If not select anything on screen)		
Next screen		Press
Previous screen		Press
To change any value on screen (If select something on screen)		Press
To increase existing value		Press
To decrease existing value		Press
To exit existing menu		Press
To activate "boost" function ²		Press for 3 seconds
To reset the unit ³		Press for 3 seconds
To reset the duration of filter contamination depending time ⁴		Press for 3 seconds
To adjust screen brightness and contrast		Press for 3 seconds
Child lock		Press for 3 seconds



¹ Cannot open or close if BMS ([Part II – Section 8.1](#)) is active

² Cannot change the fan speed if "Boost" function is active

³ Reset works if the unit is off

⁴ Cannot work if the unit has filter sensor

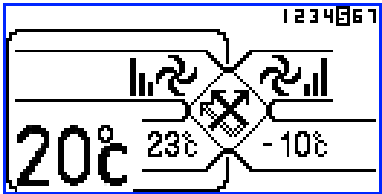
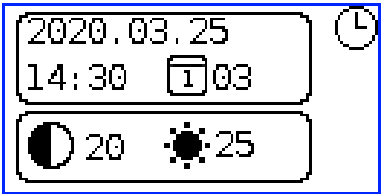
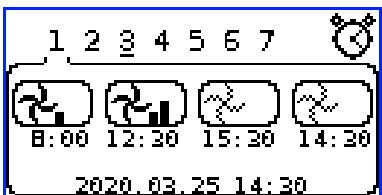
3.2.2. Screenshots

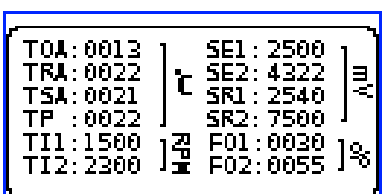
<p>1.Screen Main Screen</p>		<p>4.Screen Adjust</p>	
<p>2.Screen Timer</p>		<p>5.Screen Company Logo</p>	
<p>3.Screen Information</p>			

“1.Screen” Symbols: Main Screen

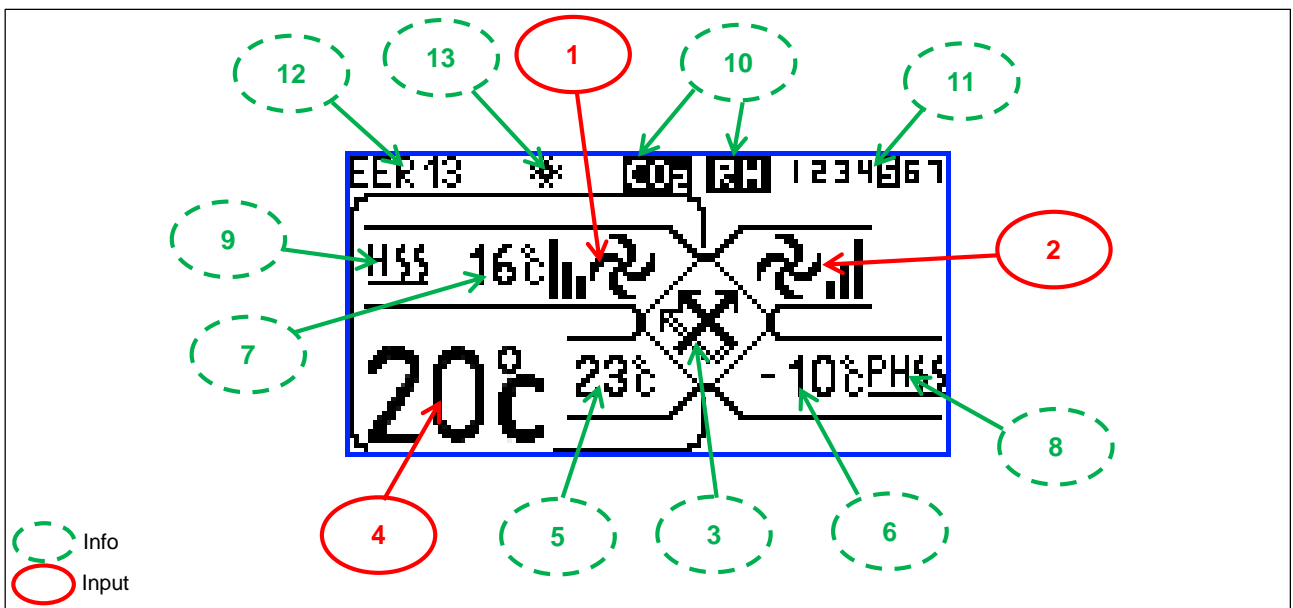







1.Symbol: Fresh Air Fan	
	Off
	Fan speed "low"
	Fan speed "med"
	Fan speed "high"
	Fan speed "boost"
	VOD mode is active



2.Symbol: Exhaust Air Fan	
	Off
	Fan speed "low"
	Fan speed "med"
	Fan speed "high"
	Fan speed "boost"
	VOD mode is active

3.Symbol: Heat exchanger (Plate or Rotor) & By-Pass damper			
	Exchanger: Plate type By-Pass: not available Unit: Off		Exchanger: Plate type By-Pass: Available / Closed Unit: Off
	Exchanger: Plate type By-Pass: not available Unit: Working		Exchanger: Plate type By-Pass: Available / Closed Unit: Working
	Exchanger: Rotor type By-Pass: not available Unit: Off		Exchanger: Plate type By-Pass: Available / Open Unit: Working
	Exchanger: Rotor type By-Pass: not available Unit: Working		

4.Symbol	Controller temperature (T_PA). Temperature set value when selected.
5.Symbol	Return air temperature (T_RA)
6.Symbol	Outdoor air temperature (T_OA)
7.Symbol	Supply air temperature (T_SA). (If sensor is available)



8.Symbol: Preheater	
	Not available
	Type: Preheater Status: Off
	Type: Preheater Status: Open

9.Symbol: Heating and/or Cooling Equipment Symbol			
	Not available		Type: Water coil Status: Off
	Type: Heater Status: Off		Type: Water coil Status: Open / Cooling mode
	Type: Heater Status: Open		Type: Water coil Status: Open / Heating mode

10.Symbol: Sensor Symbol	
	CO ₂ sensor is available (Part I – Section 4.1.3 or 4.1.4)
	Humidity sensor is available (Part I – Section 4.1.2 or 4.1.4)
	Sensor supplied by the user

11.Symbol: Timer Symbol	
	The day of the week
	BMS is active

12.Symbol	Fault code
------------------	------------

13.Symbol: Defrost Symbol	
	Frost protection is active
	Frost protection is active for DX system

“2.Screen” Symbols: Timer

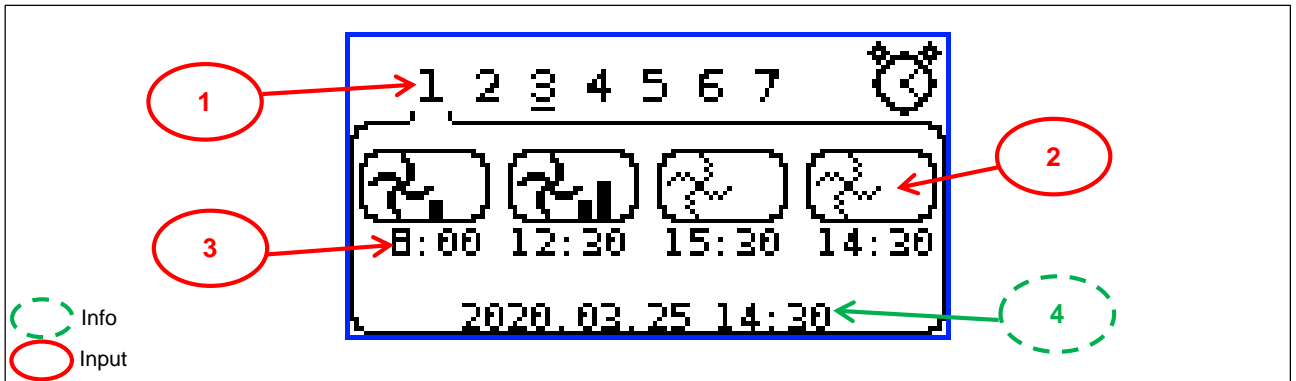

1.Field	Day of the week selection
2.Field	Fan mode selection
3.Field	Clock selection
4.Field	System time information

“3.Screen” Symbols: Information

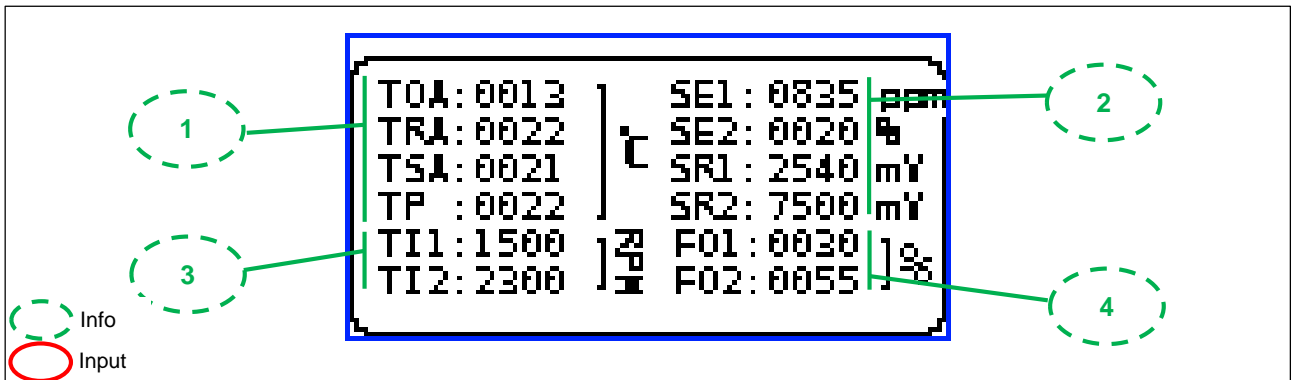

1.Field	Temperature sensor values [°C]
2.Field	Sensor values [mV]
3.Field	Fan speed values [rpm] (if fan tacho connection is available)
4.Field	Fan speed values [%]

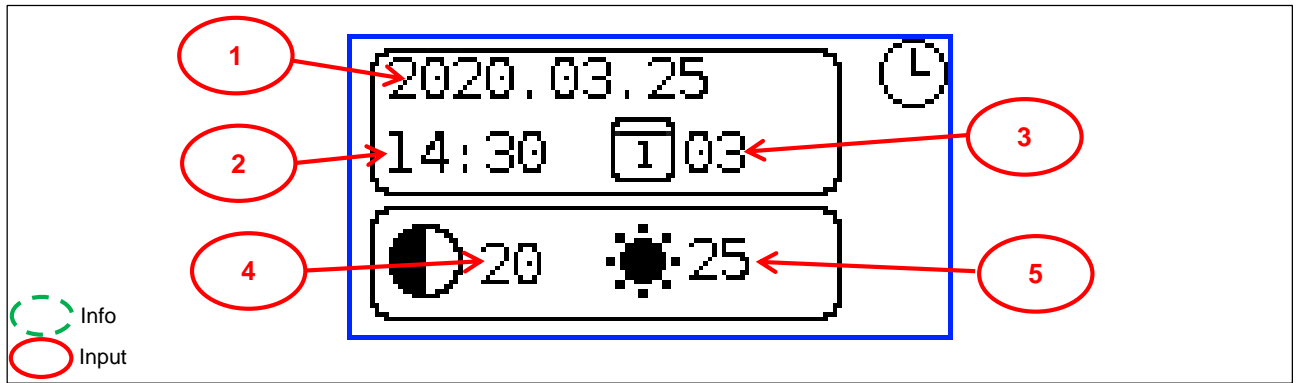
“4.Screen” Symbols: Settings

1.Field	Date setting [YYYY.MM.DD]
2.Field	Clock setting [HH:MM]
3.Field	1 st day of the week selection. For example, if the 1 st day of the week is Monday and today is Wednesday, the entry value should be 3, if the 1 st day of the week is Sunday and today is Wednesday, the entry value should be 4
4.Field	Screen contrast value
5.Field	Screen brightness value

3.2.3. Cable connection

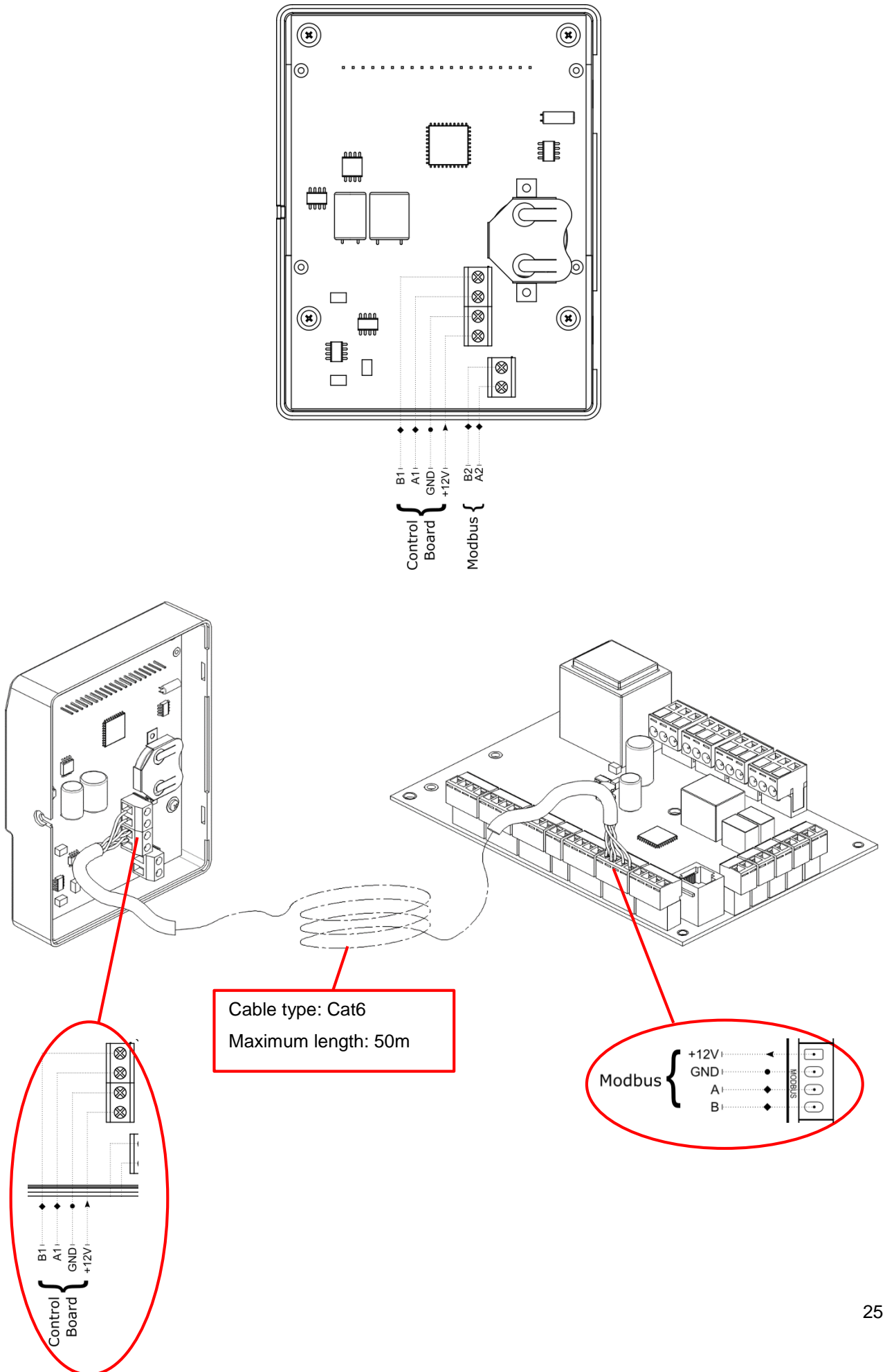

3.2.4. Surface mounting

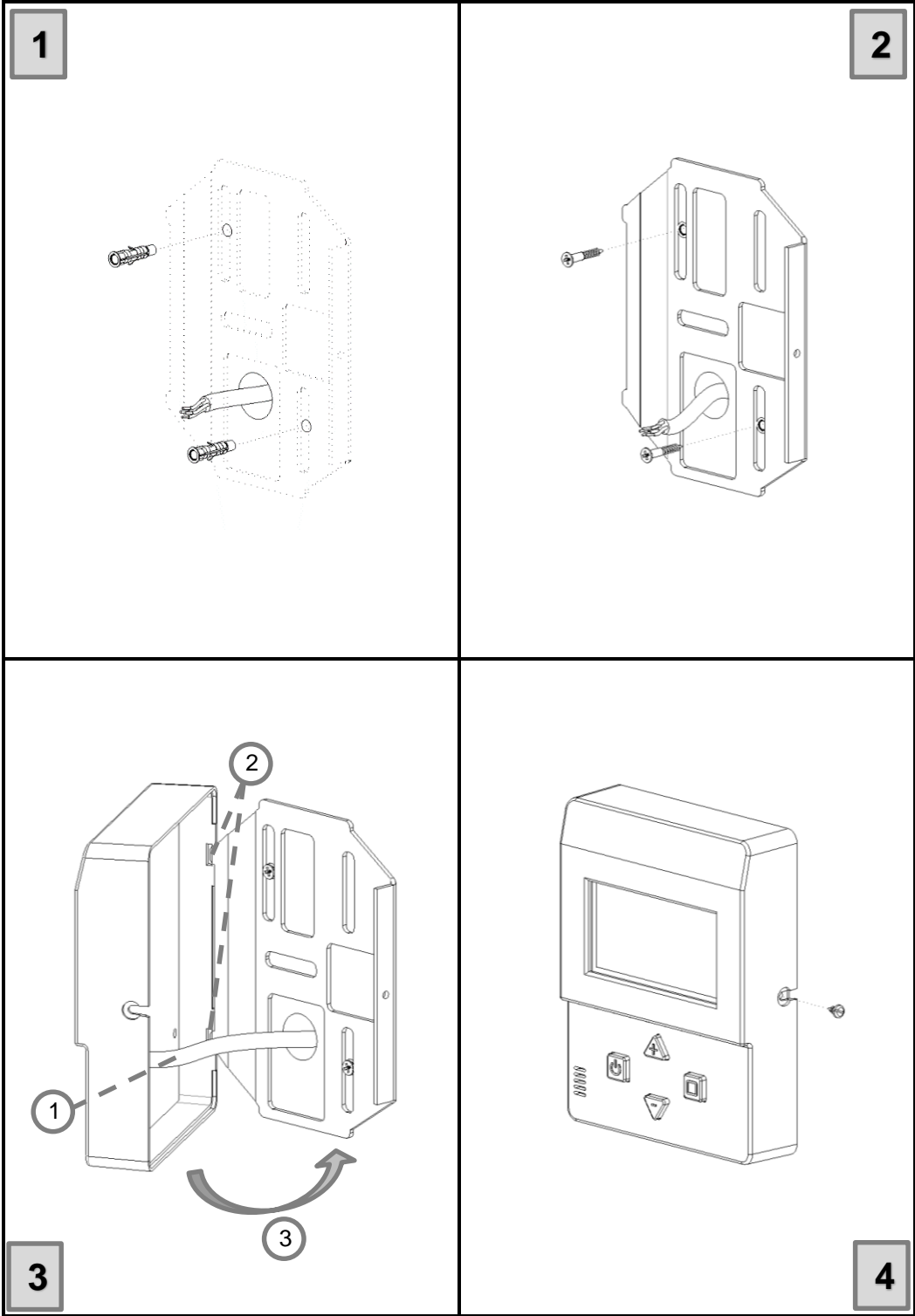

4. Accessories

4.1. Sensors

4.1.1. Temperature Sensor (90001316)

NTC 10kΩ (@25°C) type sensor used for air temperature measurement. The control board is calibrated according to this sensor. Duct type sensor is also suitable to use.

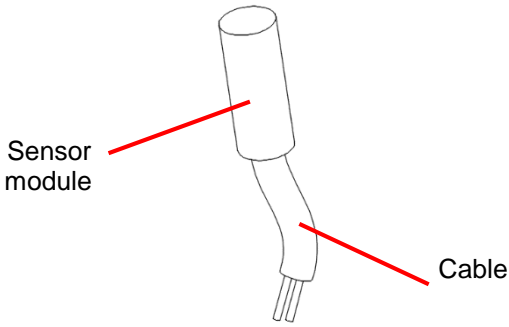
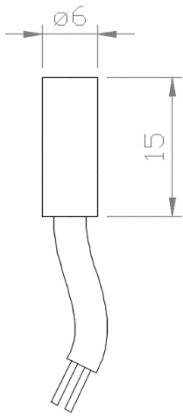
Appearance	Dimensions
 <p>Sensor module</p> <p>Cable</p>	 <p>Ø6</p> <p>15</p>

4.1.2. Humidity Sensor (90001322)

It is the sensor used to measure the humidity of the air. The control board is calibrated according to this sensor. Duct type sensor is also suitable to use.

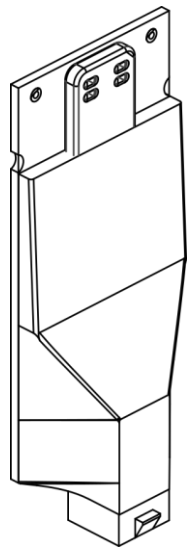
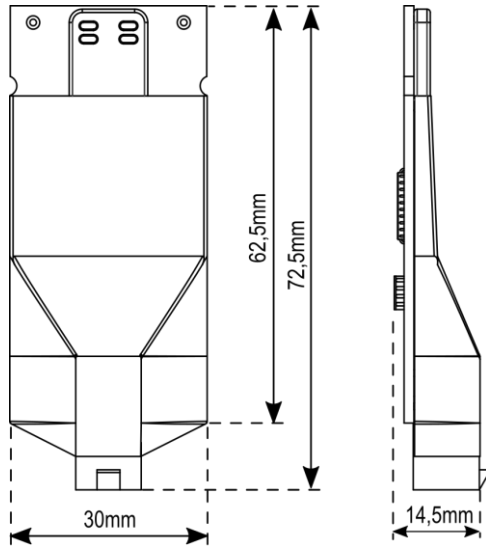
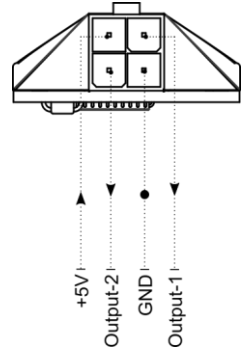
Appearance	Dimensions	Connection
	 <p>30mm</p> <p>62,5mm</p> <p>72,5mm</p> <p>14,5mm</p>	 <p>+5V</p> <p>Output-2</p> <p>GND</p> <p>Output-1</p>

4.1.3. Carbon dioxide (CO₂) Sensor (90001319)

It is the sensor used to measure the amount of carbon dioxide (CO₂) in the air. The control board is calibrated according to this sensor. Duct type sensor is also suitable to use.

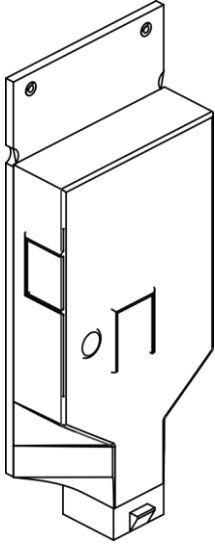
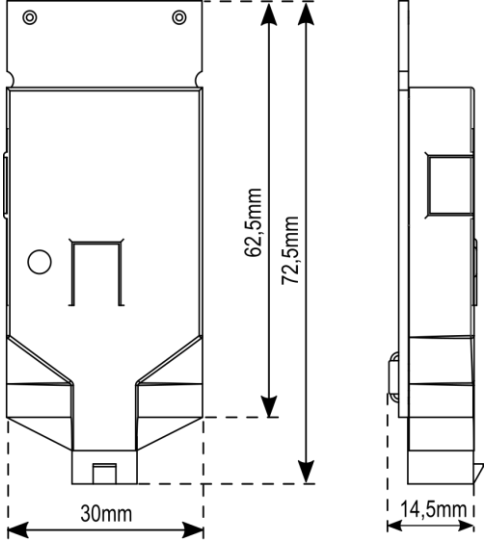
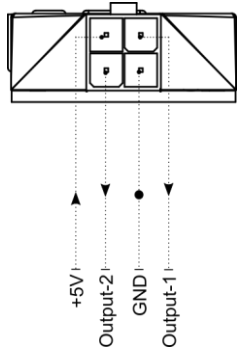
Appearance	Dimensions	Connection
		

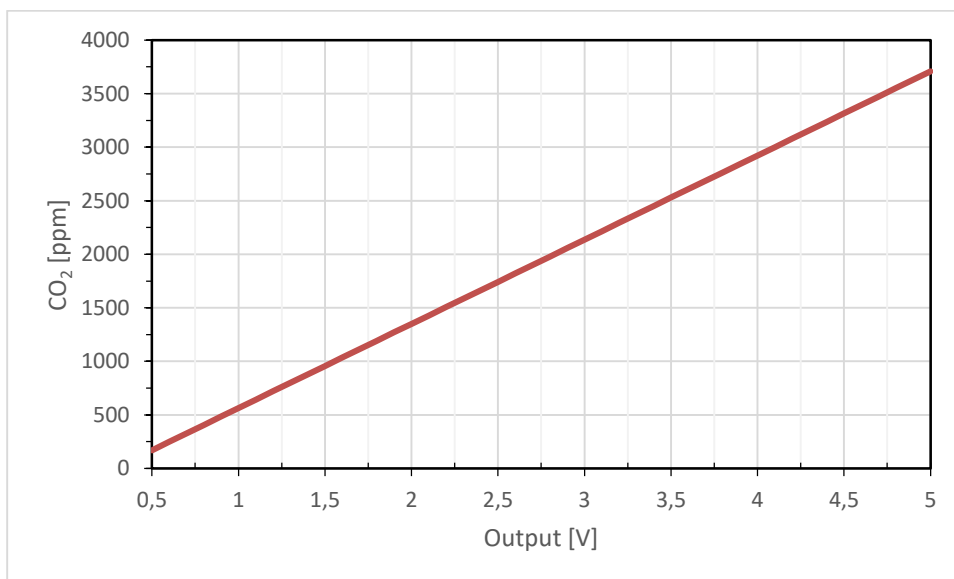

4.1.5. Pressure transmitter

It is the sensor used to measure the air pressure difference. It can be used for constant flow, constant pressure functions and filter pollution measurement. The control board is calibrated according to this sensor. Duct type sensor is also suitable to use.

PART II – WORKING SCENARIO

1. Fan Speed Control

I/O	Control Board: F_OA, F_RA, C_OA, C_RA Control Controller: Fan speed selection		
	Description	Register	Default
	Mode selection	100	"standard"
	Alarm type selection for fresh air fan	103	"tacho"
	Alarm type selection for exhaust air fan	104	"tacho"
	Fault detection time for fan	105	10 s
	PWM reference value (low) for fresh air fan	106	%30
	PWM reference value (high) for fresh air fan	107	%80
	PWM reference value (low) for exhaust air fan	108	%30
	PWM reference value (high) for exhaust air fan	109	%80
	VOD Status	122	"passive"

There are 3 speed levels (L, M, H) and 1 "boost" speed, in total 4 speed levels. Control board medium speed "M"; is calculated from the arithmetic mean of the low "L" and high "H" speeds. Depending on the structure and feature of the device, these speed step values can be changed.

Fan failure information is set to "tacho" as standard.

Alternatives such as the following are available for fan speed control.

- ❖ Alternative-1: Manual control
 - Single fan mode. Operating only fresh air or exhaust fan (except Basic Controller)
 - Separate speed control of 2 fans (except Basic Controller)
- ❖ Alternative-2: Automatic
 - VOD mode with humidity, CO₂ or different sensors.
 - Constant flow / Constant pressure

2. Boost Function

I/O	Control Board: DI (BST) Control Controller: Boost function selection		
	Description	Register	Default
	Boost Controller status	115	"active"
	PWM value (boost) for Controller	116	%100
	Boost duration for Controller	117	15 min.
	PWM value (boost) for Control Board [BST]	118	%80
	Boost duration for Control Board [BST]	119	1 min.
	Control Board DI1 Selection	170	"BST"

If necessary, the fan speed of the device is set to the fastest position temporarily.

- ❖ Manual: By pressing the button on the controller. The fans of the device operate at the highest speed (boost speed) for a certain period of time. It then continues at normal operating speed.
- ❖ Automatic: Fans will run at Boost speed when a signal is received from input [BST]. The fans run in Boost for a specific amount of time, then continue at normal operating speed.

3. Filter Control

I/O	Control Board: DI (F11, F12) Control Controller: ---		
	Description	Register	Default
	Filter-1 fouling time reference	135	3000
	Filter-2 fouling time reference	136	3000
	Control Board DI5 Selection	174	"F11"

Filters on the device must be cleaned at certain times. It is the function that indicates the time of cleaning.

- ❖ Alternative-1: Device operating time is monitored, and the control displays a warning to clean the filter when the set time has expired (default).
- ❖ Alternative-2: The filter can be controlled mechanically. The function is activated with the differential pressure switch (NC) to be connected to the control card [FIL] input. Thus, when the filter becomes dirty, the control displays a warning to clean the filter. When this function is active, the filter's time control is disabled.

4. By-Pass & Rotor Control

4.1. By-Pass Control

I/O	Control Board: DO (BYP), T_OA, Room temperature T_RO (T_RA or T_PA) Control Controller: Set temperature selection		
	Description	Register	Default
	By-Pass status	131	"active"
	By-Pass position change waiting time reference	132	30 sn
	Room temperature sensor selection	130	"T_RA"
	Temperature sensor selection for electric heater	140	"T_RO" (reg 130)
	Control Board LP0 Selection	159	"BYP"

It is better not to use heat recovery heat exchanger in terms of energy saving and comfort during the transition seasons, when the temperature of the outdoor air drops during the night in the summer or when the temperature of the outdoor air rises at noon in the winter. In these cases, the fresh air can be passed directly to the indoor environment by passing the heat recovery exchanger. Depending on the outside temperature, set temperature and indoor temperature, the control card decides whether to activate the by-pass.

It has on/off control feature.

4.2. Rotor Control

I/O	Control Board: DO (RTR), T_OA, Room temperature T_RO (T_RA or T_PA) Control Controller: Set temperature selection		
	Description	Register	Default
	Room temperature sensor selection	130	"T_RA"
	Temperature sensor selection for electric heater	140	"T_RO" (reg 130)
	Control Board LP4 Selection	163	"RTR"

It is used to control the motor of the rotor on/off in ventilation units with rotor type heat recovery exchanger. In the transition seasons, it is better not to use the heat recovery rotor in terms of energy saving and comfort when the temperature of the outdoor air drops during the summer hours or the temperature of the outdoor air

risers at noon in the winter. In these cases, the rotor is stopped, and fresh air can be delivered directly to the indoors. Depending on the outside temperature, set temperature and indoor temperature, the control card decides whether the rotor will operate.

5. Heating & Cooling Control

It provides control of the additional heater and/or cooler used to ensure that the fresh air handled from the heat recovery device is in comfort conditions. Equipment can be operated depending on room or return air temperature, or they can be operated depending on the supply air temperature.

5.1. Electric Heater Control [HT]

I/O	Control Board: DO (HT1, HT2, HT3), DI (HTI), Room temperature (T_RA or T_PA) or T_SA Control Controller: Set temperature selection		
	Description	Register	Default
	Heater status [HT]	137	"active"
	Electric heater cooling time reference	139	30 s
	2.stage temperature difference	129	3°C
	Room temperature sensor selection	130	"T_RA"
	Temperature sensor selection for electric heater	140	"T_RO" (reg 130)
	Control Board LP1 Selection	160	"HT1"
	Control Board LP2 Selection	161	"HT2"
	Control Board DI4 Selection	173	"HTI"

It is the stage control of the electric after heater used to increase the supply air temperature to the comfort temperature or the water heater battery valve control (on/off) function. It can be operated according to room temperature or supply air temperature.

There is a fault input for the electric heater (dry contact NC). If this connection is made, a malfunction in the electric heater will be shown on the control controller and will disable the electric heater.

5.2. Water Coil Control [CW]

I/O	Control Board: DO (CWO), DI (CWI), Room temperature (T_RA or T_PA) or T_SA Control Controller: Set temperature selection		
	Description	Register	Default
	Water coil status [CW]	177	"passive"
	Water coil mode selection	178	"auto"
	Water coil position change waiting time reference	179	60 s.
	Room temperature sensor selection	130	"T_RA"
	Temperature sensor selection for electric heater	140	"T_RO" (reg 130)

The water coil (for heating & cooling) used to ensure that the supply air reaches the comfort temperature is the valve control (on/off) function. It can be operated according to room temperature or supply air temperature. Depending on the purpose of use, heating (HEAT), cooling (COOL) or heating & cooling (AUTO) operation can be selected.

There is a fault input for the water coil (dry contact NC). If this connection is made, a malfunction in the water coil will be shown on the control controller and will disable the water coil.

5.3. Heating-Cooling System with Refrigerant (DX System) [DX]

I/O	Control Board: DO (DX1, DX2, DX3, FWV), DI (DXH, DXL, DXI), Room temperature (T_RA or T_PA) or T_SA Control Controller: Set temperature selection, Working mode selection		
	Description	Register	Default
	DX system status [DX]	165	"passive"
	DX system mode selection	166	"auto"
	DX system supply temperature waiting time	167	600 s
	DX system supply temperature minimum value	168	16°C
	DX system supply temperature maximum value	169	32°C
	2.stage temperature difference	129	3°C
	Room temperature sensor selection	130	"T_RA"
	Temperature sensor selection for equipment	140	"T_RO" (reg 130)

It is the function that provides the control of Heat Recovery Devices with heat pump (freon cooling) System. The operating mode of the Freon Cooling system ("Fan", "Cool", "Heat", "Auto") is determined by the user. Control Card adjusts its operation according to the selected mode. If the low-high gas pressure switches in the Freon Cooling System are connected to the Control Card, the system is monitored for failure.

6. Frost Protection [FRZ]

I/O	Control Board: DO (PH1, PH2), DI (HTI), T_OA Control Controller: ---		
	Description	Register	Default
	Frost temperature	146	0°C
	Frost protection status	145	"By-Pass"
	Frost protection scenario control time	---	15 min.
	Frost protection scenario runtime	147	%25
	Pre-heater status [PH]	138	"active"
	Control Board LP3 Selection	162	"PH1"
	Control Board DI4 Selection	173	"HTI"

In cases where the outside temperature is low; It is a function that prevents damage to the heat exchanger as a result of frozen condensed water in the heat recovery exchanger.

- ❖ Alternative-1: By-Pass damper method (default).
- ❖ Alternative-2: Fan speed change method: Fresh air fan will run at low speed "L" and exhaust fan will operate at high speed "H".
- ❖ Alternative-3: Fan speed change method: Fresh air fan off, exhaust fan will continue at operating speed.
- ❖ Pre-heater method: If a pre-heater is mounted on fresh air duct, it will be activated. There is a fault input for the electric heater (dry contact NC). If this connection is made, a malfunction in the electric heater will be shown on the control controller and will disable the electric heater.

7. Room Temperature Sensor Function [T_RO]

I/O	Control Board: T_RA Control Controller: T_PA		
	Description	Register	Default
	Room temperature sensor selection	130	"T_RA"

Control board; it needs to measure the room temperature to operate many functions. The following alternatives can be used for this measurement.

- ❖ Alternative-1: Return air temperature.
- ❖ Alternative-2: Room control controller temperature (expect Basic Controller).

8. BMS Function

These are the inputs and outputs used to easily control some simple functions of the Control Board.

8.1. External on/off control [BMS]

I/O	Control Board: DI (BMS) Control Controller: ---		
	Description	Register	Default
	BMS in status	180	"passive"
	Control Board DI2 Selection	171	"BMS"

It is the function that enables the control card to be opened and off with a dry contact to be connected from the outside. When this function is activated; the device will turn on and off according to the signal at the BMS input. The device will not be able to open and close from any control controller (Basic Controller, Digital Controller, etc.). The Time Function will be disabled.

8.2. Status info (Run out) [RUN]

I/O	Control Board: DO (RUN) Control Controller: ---		
	Description	Register	Default
	Control Board DO1 Selection	157	"RUN"

It is the output of information indicating whether the device is working (dry contact).

8.3. Fault info (Fault out) [FLT]

I/O	Control Board: DO (RUN) Control Controller: ---		
	Description	Register	Default
	Control Board DO2 Selection	158	"FLT"

It is the information output (dry contact) indicating the device's malfunction.

9. Modbus Function

It is the function that controls all the functions and settings of the device through the Building Management System.

9.1. Properties

Control board uses Modbus RTU protocol via RS485 connection. The unit works as Slave and the information can be taken from an external Master module.

Connection information of the unit	
Connection type	Modbus RTU Slave
Standard address	1
Link speed	9600

Party	None
Data bits	8
Stop bit	1

9.2. Connection

Communication network is showed below. Control board can be connected to RS485 on which is connected more than one unit. Address conflicts on this cable should be removed and necessary software settings should be done for data communication.

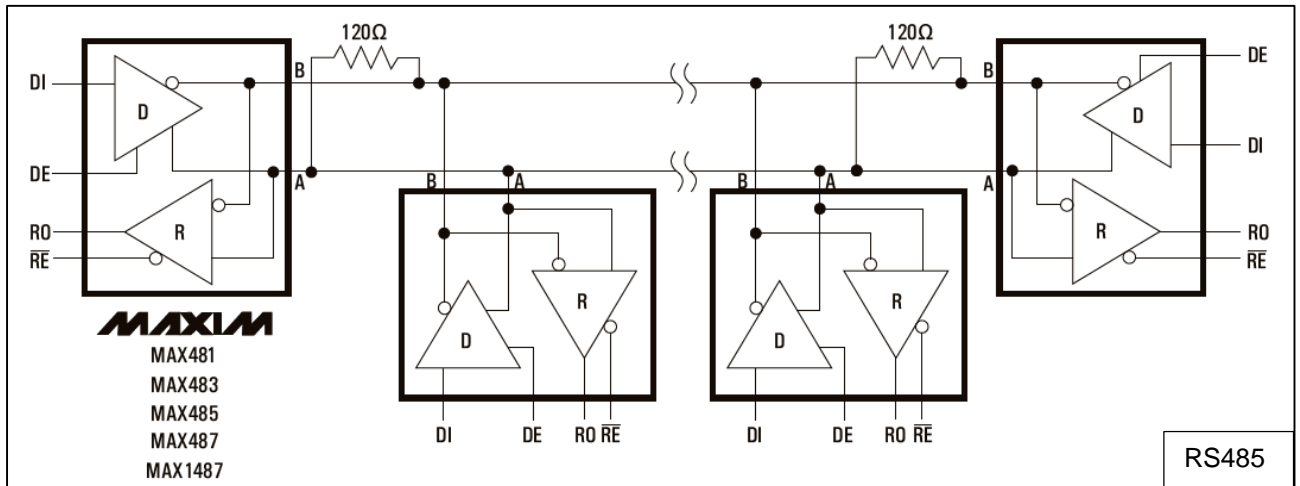

If the cable is too long or if any communication problem occurs, 120 Ohm resistance should be added at the beginning and end of the line as shown on schema.

9.3. Modbus Function

Communication package (below table) is the same for each function. First address information of relevant module is sent on package. After added information type, CRC code which is a failure code that evaluates accuracy of package is sent.

Modbus Package Type:

Address Information	Function Code	Data	Failure Control (CRC16)
---------------------	---------------	------	-------------------------

Control board supports only two of standard functions of Modbus. These codes are 03 register reading and 06 register writing (below table). In the example below, master wants to know the 16 bit data on 2nd register. Corresponding response value of control board is shown on the table below. In the second example, master wants to write the 16 bit data on 2nd register and it is reported to control board that the data was written.

Function 03 Transfer Package Example:

Master Transfer				
Address Information	Function Code	Register ID	Data Length	Failure Control
0x01	0x03	0x00,0x02	0x00,0x01	0x25,0xCA
Response of Control Board				
Address Information	Function Code	Register ID	Data Length	Failure Control
0x01	0x03	0x00	0x07,0xFF	0xFA,0x34

Function 03 Transfer Package Example:

Master Transfer				
Address Information	Function Code	Register ID	Written Data	Failure Control
0x01	0x06	0x00,0x02	0x0C,0x00	0x2D,0x0A
Response of Control Board				
Address Information	Function Code	Register ID	Written Data	Failure Control
0x01	0x06	0x00,0x02	0x0C,0x00	0x2D,0x0A

9.4. Modbus Register List

Modbus	Log	ID	Definition	Multiplier	Access	Unit	Limit	Default	Description
X		0	Software version	1	r	-	-	-	Version number [MMYY]
X	X	1	Unit ON / Off	1	rw	-	[0,1]	0	0-Stop / 1-Start
X	X	2	Alarm code	1	r	-	-	0	Failure code
X		3	Fresh air fan speed	1	r	rpm	-	-	-
X		4	Exhaust air fan speed	1	r	rpm	-	-	-
X		5	PWM value of fresh air fan	1	r	%	[0,100]	-	PWM
X		6	PWM value of exhaust air fan	1	r	%	[0,100]	-	PWM
X		7	PWM reference of fresh air fan	1	rw	%	[0,100]	-	PWM %0 (L/M/H mode), %1~20 single fan mode, %20~100 PWM mode
X		8	PWM reference of exhaust air fan	1	rw	%	[0,100]	-	PWM %0 (L/M/H mode), %1~20 single fan mode, %20~100 PWM mode
X	X	16	UV lamp On-Off	1	r	-	[0,1]	0	0-Off / 1-On
X		20	Outdoor air temperature	0,1	r	°C	[-40,80]	-	T_OA
X		21	Return air temperature	0,1	r	°C	[-40,80]	-	T_RA
X		22	Supply air temperature	0,1	r	°C	[-40,80]	-	T_SA
X		23	Controller temperature	0,1	rw	°C	[-40,80]	-	T_PA
X		24	1.Sensor value	0,01	rw	V	-	-	Voltage value of SE1
X		25	2.Sensor value	0,01	rw	V	-	-	Voltage value of SE2
X		26	RF 1.Sensor value	0,01	rw	V	-	-	Voltage value of SR1
X		27	RF 2.Sensor value	0,01	rw	V	-	-	Voltage value of SR1
X		28	1.Sensor real value	1	r	-	-	-	Processed data of input SE1 Part I – Section 4.1)
X		29	2.Sensor real value	1	r	-	-	-	Processed data of input SE2 Part I – Section 4.1)
X		30	RF 1.Sensor real value	1	r	-	-	-	Processed data of RF1 input
X		31	RF 2.Sensor real value	1	r	-	-	-	Processed data of RF2 input
X	X	42	Run info [RUN]	1	r	-	[0,1]	-	0-Off / 1-Run
X	X	43	Fault info [FLT]	1	r	-	[0,1]	-	0-No fault / 1-There is a fault
X	X	44	By-Pass info [BYP]	1	r	-	[0,1]	-	0-Off / 1-On
X	X	45	Electric heater 1.stage [HT1]	1	r	-	[0,1]	-	0-Off / 1-On
X	X	46	Electric heater 2.stage [HT2]	1	r	-	[0,1]	-	0-Off / 1-On
X	X	47	Electric heater 3.stage [HT3]	1	r	-	[0,1]	-	0-Off / 1-On
X	X	48	Electric preheater 1.stage [PH1]	1	r	-	[0,1]	-	0-Off / 1-On
X	X	49	Electric preheater 2.stage [PH2]	1	r	-	[0,1]	-	0-Off / 1-On
X	X	50	Rotor [RTR]	1	r	-	[0,1]	-	0-Off / 1-On

Modbus	Log	ID	Definition	Multiplier	Access	Unit	Limit	Default	Description
X	X	51	Ultraviolet lamp [UVL]	1	r	-	[0,1]	-	0-Off / 1-On
X	X	52	Water coil [CWO]	1	r	-	[0,1]	-	0-Off / 1-On
X	X	53	DX system 1.stage [DX1]	1	r	-	[0,1]	-	0-Off / 1-On
X	X	54	DX system 2.stage [DX2]	1	r	-	[0,1]	-	0-Off / 1-On
X	X	55	DX system four way valve [FWV]	1	r	-	[0,1]	-	0-Off / 1-On
X	X	56	Frost protection scenario [FRZ]	1	r	-	[0,1]	-	0-Off / 1-On
X	X	57	Season info [SEA]	1	r	-	[0,1]	-	0-Winter / 1-Summer
X	X	58	DX system frost protection [FDF]	1	r	-	[0,1]	-	0-Off / 1-On
X	X	63	Control Board DO1 Output	1	r	-	[0,1]	-	0-Off / 1-On
X	X	64	Control Board DO2 Output	1	r	-	[0,1]	-	0-Off / 1-On
X	X	65	Control Board LP0 Output	1	r	-	[0,1]	-	0-Off / 1-On
X	X	66	Control Board LP1 Output	1	r	-	[0,1]	-	0-Off / 1-On
X	X	67	Control Board LP2 Output	1	r	-	[0,1]	-	0-Off / 1-On
X	X	68	Control Board LP3 Output	1	r	-	[0,1]	-	0-Off / 1-On
X	X	69	Control Board LP4 Output	1	r	-	[0,1]	-	0-Off / 1-On
X	X	70	Boost input [BST]	1	r	-	[0,1]	-	0-Off / 1-On
X	X	71	BMS in [BMS]	1	r	-	[0,1]	-	0-Off / 1-On
X	X	72	Fire alarm input [FRE]	1	r	-	[0,1]	-	0-Off / 1-On
X	X	73	Heater failure info input [HTI]	1	r	-	[0,1]	-	0-Off / 1-On
X	X	74	Filter-1 alarm input [FI1]	1	r	-	[0,1]	-	0-Off / 1-On
X	X	75	DX system high pressure alarm input info [DXH]	1	r	-	[0,1]	-	0-Off / 1-On
X	X	76	DX system low pressure alarm input info [DXL]	1	r	-	[0,1]	-	0-Off / 1-On
X	X	77	Filter-2 alarm input [FI1]	1	r	-	[0,1]	-	0-Off / 1-On
X	X	78	Water coil failure info [CWI]	1	r	-	[0,1]	-	0-Off / 1-On
X	X	79	DX system failure info [DXI]	1	r	-	[0,1]	-	0-Off / 1-On
X	X	80	Service door info [SDI]	1	r	-	[0,1]	-	0-Off / 1-On
X	X	85	Control Board DI1 input	1	r	-	[0,1]	-	0-Off / 1-On
X	X	86	Control Board DI2 input	1	r	-	[0,1]	-	0-Off / 1-On
X	X	87	Control Board DI3 input	1	r	-	[0,1]	-	0-Off / 1-On
X	X	88	Control Board DI4 input	1	r	-	[0,1]	-	0-Off / 1-On
X	X	89	Control Board DI5 input	1	r	-	[0,1]	-	0-Off / 1-On
X	X	100	Mode selection	1	rw	-	[0,1]	0	0- Standard fan speed / 1- VOD
X	X	101	Fresh air fan speed stage	1	rw	-	[0,3]	0	0-Low / 1-Med / 2-High / 3-Stop
X	X	102	Exhaust air fan speed stage	1	rw	-	[0,3]	0	0-Low / 1-Med / 2-High / 3-Stop
X	X	128	Set temperature	1	rw	°C	[18,28]	22	-
X	X	166	DX system mode selection	1	rw	-	[0,3]	0	0-Auto / 1-Cool / 2-Heat / 3-Fan
X	X	178	Water coil mode selection	1	rw	-	[0,3]		0-Auto / 1-Cooling / 2-Heating

10. Timer Function

It is the function where the schedule program of the unit is set weekly. 4 different operating modes can be selected for each day of the week. The unit controls the operation according to the set mode at the specified day and time and continues to work in this mode until the next set time.

11. Fire Scenario [FRE]

I/O	Control Board: DI (FRE), DO (FLT) Control Controller: ---		
	Description	Register	Default
	Fire scenario selection	182	"off"
	Control Board DI3 Selection	172	"FRE"

It is the function that determines the working position of the device in case of fire. When a signal is received from the [FRE] input (dry contact) of the control board, it will operate depending on one of the following scenarios.

- ❖ Alternative-1: The unit will shut down (default).
- ❖ Alternative-2: Fresh air fan high speed "H", exhaust fan high speed "H"
- ❖ Alternative-3: Fresh air fan high speed "H", exhaust fan off
- ❖ Alternative-4: Fresh air fan off, exhaust fan high speed "H"

12. Child Proof Protection Function

I/O	Control Board: --- Control Controller: ---		
	Description	Register	Default
	Child proof protection method selection	149	"manual"

It is the function that prevents the control controller from being tampered with, especially by children. When the function is activated, the keys are locked and do not fulfill their duties.

- ❖ Alternative-1: Manual: Optionally, the function can be activated and deactivated by pressing the key combination on the control controller.
- ❖ Alternative-2: Time dependent: When this function is activated; The function is activated when the keys are not pressed for a certain period of time.

13. Unit Status When Power On

I/O	Control Board: --- Control Controller: ---		
	Description	Register	Default
	Unit start when power on	151	"active"
	Unit status when power on	150	"active"

Decides what to do when the device is powered.

- ❖ Alternative-1: The device will be active with the last operating position (default).
- ❖ Alternative-2: The device will be active in "off" state.
- ❖ Alternative-3: The device will be active in the "on" position.

PART III – ALARM (Failure)

1. Fault Info (Fault out) [FLT]

The device gives a warning in the event of a malfunction in any of its equipment. The control card decides whether to continue operating according to the severity of the fault. Fault information is transmitted to the user as a fault code in use controllers (Digital Controller, Touch Controller, etc.) and warning led in the Basic Controller. In addition, the device mechanically (dry contact) exports the fault information from the "Fault out" output.

2. Fault Code List

Alarm No	Description	Register 2 value	Basic Panel ¹	Panel fault code	Unit Status	Reset
0	Unit run normally.	0	---	---	Unit run normally.	---
1	Fire alarm [FRE]	1	00001	ERR 1	Fans depends on the fire scenario. All equipment off.	Necessary
2	Electric heater failure [HTI]	2	00010	ERR 2	Only heater is off.	Not necessary
3	Fresh air fan failure [F_OA]	3	00011	ERR 3	Unit off.	Necessary
4	Exhaust air fan failure [F_RA]	4	00100	ERR 4	Unit off	Necessary
5	Outdoor air temperature sensor failure [T_OA]	5	00101	ERR 5	Unit off.	Not necessary
6	Return air temperature sensor failure [T_RA]	6	00110	ERR 6	Fans continue to run. If the return air temperature sensor is set for room temperature measurement and the equipment is operated to this sensor, all equipments off.	Not necessary
7	Panel temperature sensor failure [T_PA]	7	00111	ERR 7	Fans continue to run. If the panel temperature sensor is set for room temperature measurement and the equipment is operated to this sensor, all equipments off.	Not necessary
8	Supply air temperature failure [T_SA]	8	01000	ERR 8	Fans run. If the equipment is operated to this sensor, all equipments off.	Not necessary
9	Sensor-1 failure [SE1]	9	01001	ERR 9	Fans continue to run at normal speed ("L", "M", "H")	Necessary
10	Sensor-2 failure [SE2]	10	01010	ERR 10	Fans continue to run at normal speed ("L", "M", "H")	Necessary
11	Constant flow function maximum limit failure	11	01011	ERR 11	Unit run normally.	Not necessary
12	Filter pollution [F11]	12	01100	ERR 12	Unit run normally.	Necessary

Alarm No	Description	Register 2 value	Basic Panel ¹	Panel fault code	Unit Status	Reset
13	Clock malfunction	13	01101	ERR 13	Time function disabled.	Not necessary
14	RF communication failure	14	01110	ERR 14	Cannot communicate with RF devices.	Not necessary
15	Digital Panel (Part I – Section 3.2) or Touch Panel (Part I – Section 3.3) communication failure	15	01111	ERR 15	The device continues to operate with the last settings.	Not necessary
16	Filter pollution [FI2]	16	10000	ERR 16	Unit run normally.	Necessary
17	Service door open [SDI]	17	10001	ERR 17	Unit off.	Not necessary
19	DX system blocked	19	10011	ERR 19	Fans continue to run. DX system off.	Not necessary
20	DX system gas high pressure failure [DXH]	20	10100	ERR 20	Fans continue to run. DX system off.	Not necessary
21	DX system gas high pressure failure [DXL]	21	10101	ERR 21	Fans continue to run. DX system off.	Not necessary
22	DX system 4-way valve failure [FWV]	22	10110	ERR 22	Fans continue to run. DX system off.	Necessary
23	DX system failure [DXI]	23	10111	ERR 23	Fans continue to run. DX system off.	Not necessary
26	UV lamp warning for out of working	26	11010	ERR 26	Unit run normally.	Necessary
27	UV lamp failure [T_UV]	27	11011	ERR 27	Unit run normally. UV lamp off.	Necessary
29	Input/Output (I/O) configuration error	29	11101	ERR 29	Unit off.	Necessary

¹ Basic controller warning led fault indicator: 0 short signal, 1 long signal









Basic controller failure code: 00010

Led flash time: short – short – short – long – short / break / short – short – short – long – short / break / ...







ANNEX.A – SERVICE OPERATIONS

1. Basic Controller

BUTTONS

Function	Button	Activity
Service operation	  	Press for 3 seconds
By-Pass function on/off [BYP]		Press for 3 seconds
Equipment function on/off (Heater, preheater) [HTI]		Press for 3 seconds
BMS function on/off [BMS]		Press for 3 seconds
Exit	  	Press for 3 seconds or Wait 10 seconds



LEDS

Led	Status	Status	Function
H	 On	 Off	By-Pass function [BYP]
M	 On	 Off	Heater function (Heater, preheater) [HTI]
L	 On	 Off	BMS function [BMS]

 Led is off
  Led is on
  Blink

2. Digital Controller

BUTTONS

Function	Button	Activity
Service operation input	 	Press for 3 seconds

SCREENSHOTS

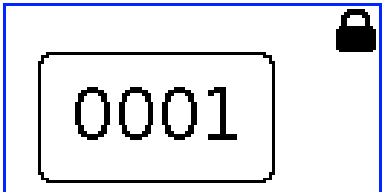
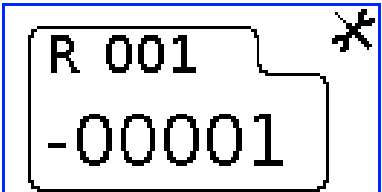
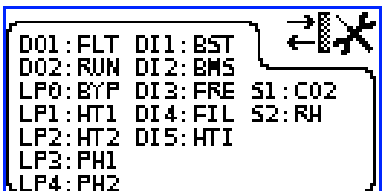
6.Screen Password screen		8.Screen Register configuration	
7.Screen I/O configure			

“6.Screen” Symbols: Password screen (Password is 1919)

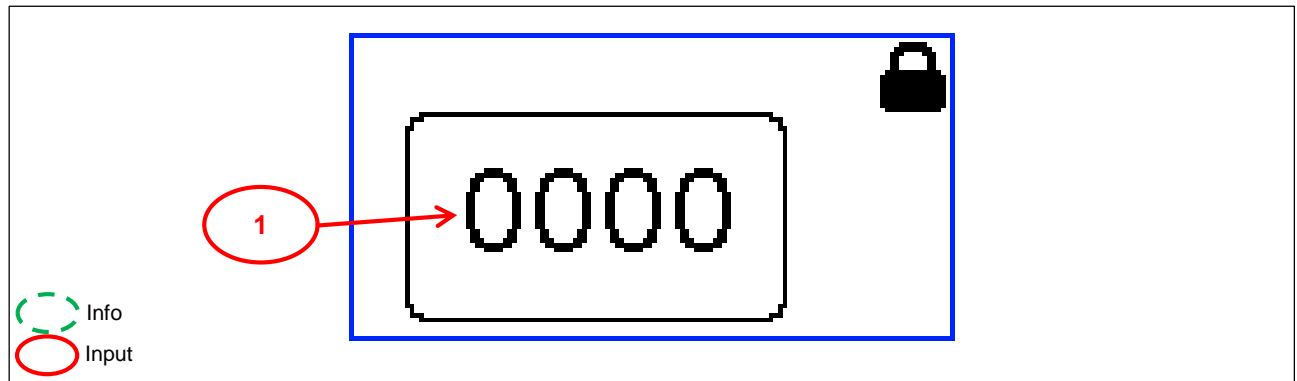

1.Field	Password entry
----------------	----------------

“7.Screen” Symbols: I/O configure screen

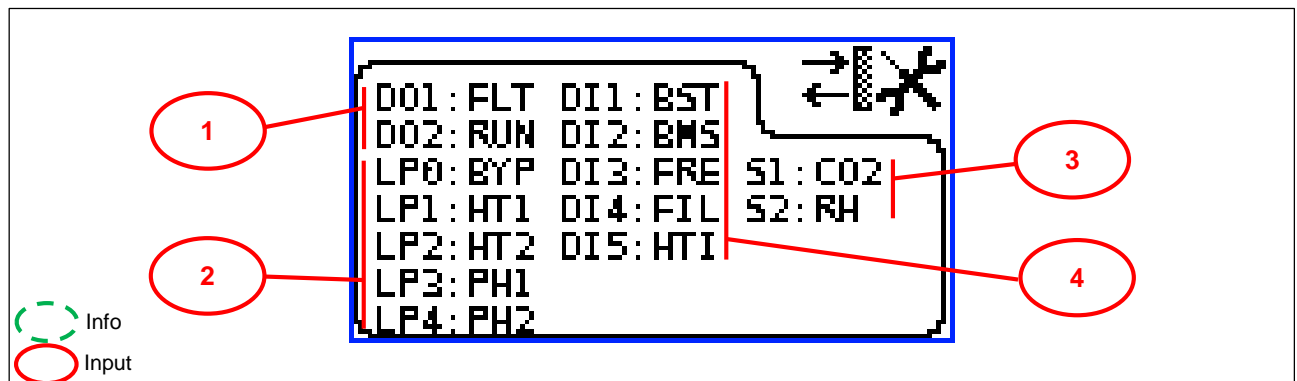

1.Field	Outputs selection (dry contact) (DO)
2.Field	Power output selection
3.Field	Inputs selection (dry contact) (DI)
4.Field	Inputs selection (sensor) (AI)

Inputs Code List (DI)			
Code	Description	Code	Description
---	Not connected	DXH	Freon system pressure failure info (Part II – Section 5.3)
BST	Boost function (Part II – Section 2)	DXL	Freon system pressure failure info (Part II – Section 5.3)
BMS	BMS unit on/off (BMS in) (Part II – Section 8.1)	F12	Filter-2 mechanical info (Part II – Section 3)
FRE	Fire info (Part II – Section 11)	CWI	Water coil failure info (Part II – Section 5.2)
HTI	Heater failure info (Part II – Section 5.1 and Section 6)	DXI	DX system failure info (Part II – Section 5.3)
FI1	Filter-1 mechanical info (Part II – Section 3)	SDI	Service door info

Outputs Code List (DO)			
Code	Description	Code	Description
---	Not connected	RTR	Rotor heat exchanger (Part II – Section 4.2)
RUN	Unit run out info (Run out) (Part II – Section 8.2)	UVL	Ultraviolet lamp
FLT	Failure info (Fault out) (Part II – Section 8.3)	CWO	Water coil (Part II – Section 5.2)
BYP	By-Pass (Part II – Section 4.1)	DX1	Freon system 1.stage (Part II – Section 5.3)
HT1	Electric Heater 1.stage (Part II – Section 5.1)	DX2	Freon system 2.stage (Part II – Section 5.3)
HT2	Electric Heater 2.stage (Part II – Section 5.1)	FWV	Freon system four-way valve (Part II – Section 5.3)
HT3	Electric Heater 3.stage (Part II – Section 5.1)	FRZ	Frost protection info (Part II – Section 6)
PH1	Electric preheater 1.stage (Part II – Section 6)	SEA	Season info
PH2	Electric preheater 2.stage (Part II – Section 6)	FDF	DX System defrost info

Inputs Code List (AI)			
Code	Description	Code	Description
---	Not connected	RH	Humidity Sensor (Part I – Section 4.1.2)
CO2	CO ₂ sensor (Part I – Section 4.1.3)	GEN	0~10V sensor (user preference)

“8.Screen” Symbol: Register configure screen

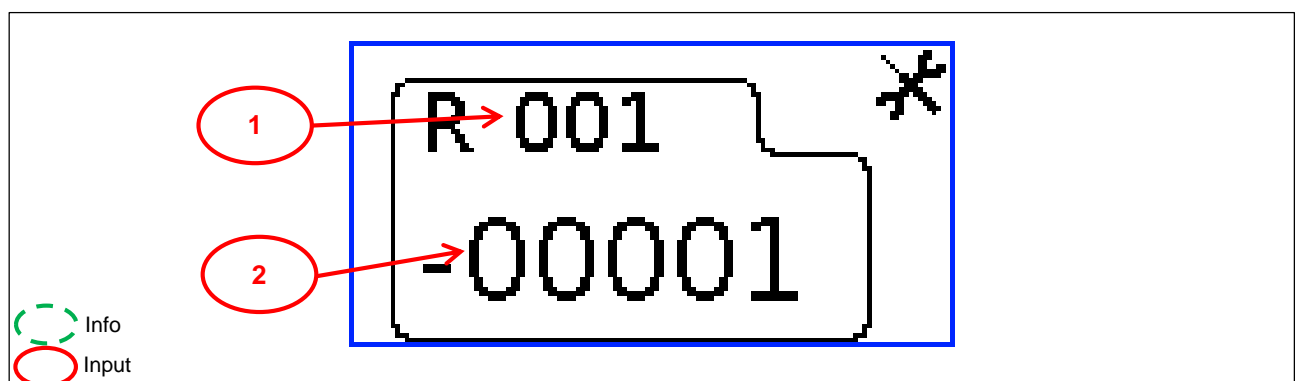

1.Field	Register number
2.Field	Register value

4. Register List

Column Name	Description
Modbus	It can be used in Modbus connection
Log	It records on the controller
ID	Register number
Definition	Definition
Multiplier	Multiplier coefficient of register value
Access	Knowledge of writing and reading authority (r: Read only, rw: Read and write)
Unit	Unit
Limit	Limit values
Default	Factory settings
Description	Description

Modbus	Log	ID	Definition	Multiplier	Access	Unit	Limit	Default	Description
X		0	Software version	1	r	-	-	-	Version number [MMYY]
X	X	1	Unit ON / Off	1	rw	-	[0,1]	0	0-Stop / 1-Start
X	X	2	Alarm code	1	r	-	-	0	Failure code
X		3	Fresh air fan speed	1	r	rpm	-	-	-
X		4	Exhaust air fan speed	1	r	rpm	-	-	-
X		5	PWM value of fresh air fan	1	r	%	[0,100]	-	PWM
X		6	PWM value of exhaust air fan	1	r	%	[0,100]	-	PWM
X		7	PWM reference of fresh air fan	1	rw	%	[0,100]	-	PWM %0 (L/M/H mode), %1~20 single fan mode, %20~100 PWM mode
X		8	PWM reference of exhaust air fan	1	rw	%	[0,100]	-	PWM %0 (L/M/H mode), %1~20 single fan mode, %20~100 PWM mode
		10	PWM value (low) of fresh air fan	1	r	%	-	-	-
		11	PWM value (med) of fresh air fan	1	r	%	-	-	-
		12	PWM value (high) of fresh air fan	1	r	%	-	-	-
		13	PWM value (low) of exhaust air fan	1	r	%	-	-	-
		14	PWM value (med) of exhaust air fan	1	r	%	-	-	-
		15	PWM value (high) of exhaust air fan	1	r	%	-	-	-
X	X	16	UV lamp On-Off	1	r	-	[0,1]	0	0-Off / 1-On
		17	Countdown for fan failure control	1	rw	s	-	-	-
		18	Countdown for boost controller	1	rw	s	-	-	Countdown starts when the algorithm is activated, otherwise it is "0"
		19	Countdown for boost control board	1	rw	s	-	-	Countdown starts when the algorithm is activated, otherwise it is "0"
X		20	Outdoor air temperature	0,1	r	°C	[-40,80]	-	T_OA
X		21	Return air temperature	0,1	r	°C	[-40,80]	-	T_RA
X		22	Supply air temperature	0,1	r	°C	[-40,80]	-	T_SA
X		23	Controller temperature	0,1	rw	°C	[-40,80]	-	T_PA
X		24	1.Sensor value	0,01	rw	V	-	-	Voltage value of SE1

Modbus	Log	ID	Definition	Multiplier	Access	Unit	Limit	Default	Description
X		25	2.Sensor value	0,01	rw	V	-	-	Voltage value of SE2
X		26	RF 1.Sensor value	0,01	rw	V	-	-	Voltage value of SR1
X		27	RF 2.Sensor value	0,01	rw	V	-	-	Voltage value of SR1
X		28	1.Sensor real value	1	r	-	-	-	Processed data of input SE1 (only valid for Destech sensors Part I – Section 4.1)
X		29	2.Sensor real value	1	r	-	-	-	Processed data of input SE2 (only valid for Destech sensors Part I – Section 4.1)
X		30	RF 1.Sensor real value	1	r	-	-	-	Processed data of RF1 input (only for our Entro V sensors)
X		31	RF 2.Sensor real value	1	r	-	-	-	Processed data of RF1 input (only for our Entro V sensors)
		32	Countdown for demo sensor value	1	rw	s	-	0	If it is a non-zero value, the sensor values can be entered manually until it becomes zero again.
		33	Countdown for By-Pass position change	1	r	s	-	-	Time is expected to be 0 for By-Pass position change
		34	Countdown for PID function	1	r	s	-	-	
		35	Filtre-1 sensor	1	r	-	[0,1]	-	Indicates whether the mechanical filter sensor is connected 0-not plugged / 1-plugged
		36	Countdown for electric heater cooling time	1	r	s	-	-	Countdown starts when the algorithm is activated, otherwise it is "0"
		37	Countdown for electric heater position change	1	r	s	-	-	Time is expected to be 0 for electric heater position change
		38	Countdown for DX System 4-way valve fault	1	r	s	-	-	Waiting time required for 4-way valve fault detection.
		39	Countdown for DX system	1	r	s	-	-	DX System shows how many times it has failed in 2 hours
		40	Countdown for frost protection function	1	r	s	-	-	Countdown starts when the algorithm is activated, otherwise it is "0"
X	X	42	Run info [RUN]	1	r	-	[0,1]	-	0-Off / 1-Run
X	X	43	Fault info [FLT]	1	r	-	[0,1]	-	0-No fault / 1-There is a fault
X	X	44	By-Pass info [BYP]	1	r	-	[0,1]	-	0-Off / 1-On
X	X	45	Electric heater 1.stage [HT1]	1	r	-	[0,1]	-	0-Off / 1-On
X	X	46	Electric heater 2.stage [HT2]	1	r	-	[0,1]	-	0-Off / 1-On
X	X	47	Electric heater 3.stage [HT3]	1	r	-	[0,1]	-	0-Off / 1-On
X	X	48	Electric preheater 1.stage [PH1]	1	r	-	[0,1]	-	0-Off / 1-On
X	X	49	Electric preheater 2.stage [PH2]	1	r	-	[0,1]	-	0-Off / 1-On
X	X	50	Rotor [RTR]	1	r	-	[0,1]	-	0-Off / 1-On
X	X	51	Ultraviolet lamp [UVL]	1	r	-	[0,1]	-	0-Off / 1-On
X	X	52	Water coil [CWO]	1	r	-	[0,1]	-	0-Off / 1-On
X	X	53	DX system 1.stage [DX1]	1	r	-	[0,1]	-	0-Off / 1-On
X	X	54	DX system 2.stage [DX2]	1	r	-	[0,1]	-	0-Off / 1-On
X	X	55	DX system four way valve [FWV]	1	r	-	[0,1]	-	0-Off / 1-On
X	X	56	Frost protection scenario [FRZ]	1	r	-	[0,1]	-	0-Off / 1-On
X	X	57	Season info [SEA]	1	r	-	[0,1]	-	0-Winter / 1-Summer
X	X	58	DX system frost protection [FDF]	1	r	-	[0,1]	-	0-Off / 1-On
X	X	63	Control Board DO1 Output	1	r	-	[0,1]	-	0-Off / 1-On
X	X	64	Control Board DO2 Output	1	r	-	[0,1]	-	0-Off / 1-On
X	X	65	Control Board LP0 Output	1	r	-	[0,1]	-	0-Off / 1-On

Modbus	Log	ID	Definition	Multiplier	Access	Unit	Limit	Default	Description
X	X	66	Control Board LP1 Output	1	r	-	[0,1]	-	0-Off / 1-On
X	X	67	Control Board LP2 Output	1	r	-	[0,1]	-	0-Off / 1-On
X	X	68	Control Board LP3 Output	1	r	-	[0,1]	-	0-Off / 1-On
X	X	69	Control Board LP4 Output	1	r	-	[0,1]	-	0-Off / 1-On
X	X	70	Boost input [BST]	1	r	-	[0,1]	-	0-Off / 1-On
X	X	71	BMS in [BMS]	1	r	-	[0,1]	-	0-Off / 1-On
X	X	72	Fire alarm input [FRE]	1	r	-	[0,1]	-	0-Off / 1-On
X	X	73	Heater failure info input [HTI]	1	r	-	[0,1]	-	0-Off / 1-On
X	X	74	Filter-1 alarm input [FI1]	1	r	-	[0,1]	-	0-Off / 1-On
X	X	75	DX system high pressure alarm input info [DXH]	1	r	-	[0,1]	-	0-Off / 1-On
X	X	76	DX system low pressure alarm input info [DXL]	1	r	-	[0,1]	-	0-Off / 1-On
X	X	77	Filter-2 alarm input [FI1]	1	r	-	[0,1]	-	0-Off / 1-On
X	X	78	Water coil failure info [CWI]	1	r	-	[0,1]	-	0-Off / 1-On
X	X	79	DX system failure info [DXI]	1	r	-	[0,1]	-	0-Off / 1-On
X	X	80	Service door info [SDI]	1	r	-	[0,1]	-	0-Off / 1-On
		83	Tacho info for fresh air fan [C_OA]	1	r	-	[0,1]	-	-
		84	Tacho info for exhaust air fan [C_RA]	1	r	-	[0,1]	-	-
X	X	85	Control Board DI1 input	1	r	-	[0,1]	-	0-Off / 1-On
X	X	86	Control Board DI2 input	1	r	-	[0,1]	-	0-Off / 1-On
X	X	87	Control Board DI3 input	1	r	-	[0,1]	-	0-Off / 1-On
X	X	88	Control Board DI4 input	1	r	-	[0,1]	-	0-Off / 1-On
X	X	89	Control Board DI5 input	1	r	-	[0,1]	-	0-Off / 1-On
		90	Controller Child proof protection	1	rw	-	-	-	-
		91	Basic Controller status	1	rw	-	-	-	Buttons info
		92	Basic Controller simulation	1	rw	-	-	-	-
		93	Basic Controller button info	1	rw	-	-	-	-
		94	Filtre-2 sensor	1	r	-	[0,1]	-	Indicates whether the mechanical filter sensor is connected 0-not plugged / 1-plugged
		95	RF Controller simulation	1	rw	-	-	-	-
		96	Countdown DX system	1	rw	s	-	-	DX System compressor position change waiting time
		97	Supply temperature countdown for DX system [T_SA]	1	rw	s	-	-	DX System compressor position change waiting time depends on T_SA
		98	Countdown DX system frost protection	1	rw	s	-	-	Countdown to DX System freeze scenario steps
		99	Factory settings	1	rw	-	-	-	-
X	X	100	Mode selection	1	rw	-	[0,1]	0	0- Standard fan speed / 1- VOD
X	X	101	Fresh air fan speed stage	1	rw	-	[0,3]	0	0-Low / 1-Med / 2-High / 3-Stop
X	X	102	Exhaust air fan speed stage	1	rw	-	[0,3]	0	0-Low / 1-Med / 2-High / 3-Stop
		103	Alarm type selection for fresh air fan	1	rw	-	[0,2]	0	0-Tacho / 1-NC / 2-NO
		104	Alarm type selection for fresh air fan	1	rw	-	[0,2]	0	0-Tacho / 1-NC / 2-NO
		105	Fault detection time for fan	1	rw	s	[5,60]	10	The period during which the failure is not detected when fan start or position change

Modbus	Log	ID	Definition	Multiplier	Access	Unit	Limit	Default	Description
		106	PWM reference value (low) for fresh air fan	1	rw	%	[20,High]	30	-
		107	PWM reference value (high) for fresh air fan	1	rw	%	[20,100]	80	-
		108	PWM reference value (low) for exhaust air fan	1	rw	%	[20,High]	30	-
		109	PWM reference value (high) for exhaust air fan	1	rw	%	[20,100]	80	-
		110	Fan output voltage setting	1	rw	%	[0,200]	120	Output voltage setting of PWM signal
		115	Boost Controller status	1	rw	-	[0,1]	1	0-Passive / 1-Active
		116	PWM value (boost) for Controller	1	rw	%	[50,100]	100	-
		117	Boost duration for Controller	1	rw	min	[1,30]	15	-
		118	PWM value (boost) for Control Board [BST]	1	rw	%	[50,100]	80	-
		119	Boost duration for Control Board [BST]	1	rw	min	[1,30]	1	-
		122	VOD Status	1	rw	-	-	0	0-Passive / 1-Active
		123	Sensor lower limit value	0,01	rw	V	[0,1000]	50	-
		124	Sensor higher limit value	0,01	rw	V	[0,1000]	270	-
		125	Double sensor algoritma	1	rw	-	[0,2]	0	0-Maximum / 1-Minimum / 2-Difference
X	X	128	Set temperature	1	rw	°C	[18,28]	22	-
		129	2.stage temperature difference	1	rw	°C	[1,10]	3	-
		130	Room temperature sensor selection	1	rw	-	[0,1]	0	0-Return air temperature sensor (T_RA) 1-Controller temperature sensor (T_PA)
		131	By-Pass status	1	rw	-	[0,1]	1	0-Passive / 1-Active
		132	By-Pass position change waiting time reference	1	rw	s	[0,3000]	30	-
		135	Filter-1 fouling time reference	1	rw	h	[200,6000]	3000	When the working time exceeds this value, it gives filter dirty failure
		136	Filter-2 fouling time reference	1	rw	h	[200,6000]	3000	When the working time exceeds this value, it gives filter dirty failure
		137	Heater status [HT]	1	rw	-	[0,1]	0	0-Passive / 1-Active
		138	Pre-heater status [PH]	1	rw	-	[0,1]	0	0-Passive / 1-Active
		139	Electric heater cooling time reference	1	rw	s	[20,600]	30	-
		140	Temperature sensor selection for equipment	1	rw	-	[0,1]	0	0-Room temperature (Register 130) 1-Supply air temperature (T_SA)
		142	Ultraviolet lamp	1	rw	-	[0,1]	0	0-Passive / 1-Active
		143	Ultraviolet lamp lifetime	1	rw	h	[0,30000]	0	Lifetime failure when runtime exceeds this value
		144	Ultraviolet lamp sensor reference	0,1	rw	°C	[0,10]	0	
		145	Frost protection status	1	rw	-	[0,1]	0	0-Passive 1-By-Pass 2-FAN_OA "off" 3-FAN_OA"low" FAN_RA"high"
		146	Frost temperature	1	rw	°C	[-10,10]	0	-
		147	Frost protection scenario runtime	1	rw	%	[5,50]	25	-
		149	Child proof protection method selection	1	rw	-	[0,1]	0	0-Manual / 1-Automatic
		150	Unit status when power on	1	rw	-	[0,1]	1	0-Passive / 1-Active
		151	Unit start when power on	1	rw	-	[0,1]	1	0-Passive / 1-Active

Modbus	Log	ID	Definition	Multiplier	Access	Unit	Limit	Default	Description
		153	Modbus Address (Control Board)	1	rw	-	[1,254]	1	-
		154	Modbus link speed	1	rw	-	[0,254]	0	0-9600
		155	Modbus connection type	1	rw	-	[0,254]	0	0-N81 RTU
		157	Control Board DO1 Selection	1	rw	-	[0,15]	1	0:---, 1:RUN, 2:FLT, 3:BYP, 4:HT1, 5:HT2, 6:HT3, 7:PH1, 8:PH2, 9:RTR, 10:UVL, 11:CWO, 12:DX1, 13:DX2, 14:FWV, 15:FRZ, 16:SEA, 17:FDF
		158	Control Board DO2 Selection	1	rw	-	[0,15]	2	0:---, 1:RUN, 2:FLT, 3:BYP, 4:HT1, 5:HT2, 6:HT3, 7:PH1, 8:PH2, 9:RTR, 10:UVL, 11:CWO, 12:DX1, 13:DX2, 14:FWV, 15:FRZ, 16:SEA, 17:FDF
		159	Control Board LP0 Selection	1	rw	-	[0,15]	3	0:---, 1:RUN, 2:FLT, 3:BYP, 4:HT1, 5:HT2, 6:HT3, 7:PH1, 8:PH2, 9:RTR, 10:UVL, 11:CWO, 12:DX1, 13:DX2, 14:FWV, 15:FRZ, 16:SEA, 17:FDF
		160	Control Board LP1 Selection	1	rw	-	[0,15]	4	0:---, 1:RUN, 2:FLT, 3:BYP, 4:HT1, 5:HT2, 6:HT3, 7:PH1, 8:PH2, 9:RTR, 10:UVL, 11:CWO, 12:DX1, 13:DX2, 14:FWV, 15:FRZ, 16:SEA, 17:FDF
		161	Control Board LP2 Selection	1	rw	-	[0,15]	5	0:---, 1:RUN, 2:FLT, 3:BYP, 4:HT1, 5:HT2, 6:HT3, 7:PH1, 8:PH2, 9:RTR, 10:UVL, 11:CWO, 12:DX1, 13:DX2, 14:FWV, 15:FRZ, 16:SEA, 17:FDF
		162	Control Board LP3 Selection	1	rw	-	[0,15]	7	0:---, 1:RUN, 2:FLT, 3:BYP, 4:HT1, 5:HT2, 6:HT3, 7:PH1, 8:PH2, 9:RTR, 10:UVL, 11:CWO, 12:DX1, 13:DX2, 14:FWV, 15:FRZ, 16:SEA, 17:FDF
		163	Control Board LP4 Selection	1	rw	-	[0,15]	9	0:---, 1:RUN, 2:FLT, 3:BYP, 4:HT1, 5:HT2, 6:HT3, 7:PH1, 8:PH2, 9:RTR, 10:UVL, 11:CWO, 12:DX1, 13:DX2, 14:FWV, 15:FRZ, 16:SEA, 17:FDF
		165	DX system status [DX]	1	rw	-	[0,1]	0	0-Passive / 1-Active
X	X	166	DX system mode selection	1	rw	-	[0,3]	0	0-Auto / 1-Cool / 2-Heat / 3-Fan
		167	DX system supply temperature waiting time	1	rw	s	[0,1000]	600	T_SA control waiting time
		168	DX system supply temperature minimum value	1	rw	°C	[5,30]	16	DX system cooling mode T_SA minimum value
		169	DX system supply temperature maximum value	1	rw	°C	[10,40]	32	DX system heating mode T_SA maximum value
		170	Control Board DI1 Selection	1	rw	-	[0,7]	1	0:---, 1:BST, 2:BMS, 3:FRE, 4:HTI, 5:FI1, 6:DXH, 7:DXL, 8:FI2, 9:CWI, 10:DXI, 11:SDI
		171	Control Board DI2 Selection	1	rw	-	[0,7]	2	0:---, 1:BST, 2:BMS, 3:FRE, 4:HTI, 5:FI1, 6:DXH, 7:DXL, 8:FI2, 9:CWI, 10:DXI, 11:SDI
		172	Control Board DI3 Selection	1	rw	-	[0,7]	3	0:---, 1:BST, 2:BMS, 3:FRE, 4:HTI, 5:FI1, 6:DXH, 7:DXL, 8:FI2, 9:CWI, 10:DXI, 11:SDI
		173	Control Board DI4 Selection	1	rw	-	[0,7]	4	0:---, 1:BST, 2:BMS, 3:FRE, 4:HTI, 5:FI1, 6:DXH, 7:DXL, 8:FI2, 9:CWI, 10:DXI, 11:SDI
		174	Control Board DI5 Selection	1	rw	-	[0,7]	5	0:---, 1:BST, 2:BMS, 3:FRE, 4:HTI, 5:FI1, 6:DXH, 7:DXL, 8:FI2, 9:CWI, 10:DXI, 11:SDI
		177	Water coil status [CW]	1	rw	-	[0,1]	0	0-Passive / 1-Active
X	X	178	Water coil mode selection	1	rw	-	[0,3]		0-Auto / 1-Cooling / 2-Heating

Modbus	Log	ID	Definition	Multiplier	Access	Unit	Limit	Default	Description
		179	Water coil position change waiting time reference	1	rw	s	[0,1000]	60	
		180	BMS in status	1	rw	-	[0,1]	0	0-Passive / 1-Active
		182	Fire scenario selection	1	rw	-	[0,3]	0	0-Cihaz "off" 1-F_OA"high" F_RA"high" 2-F_OA"off" F_RA"high" 3-F_OA"high" F_RA"off"
		185	SE1 Sensor selection	1	rw	-	[0,4]	0	0-"---" / 1-RH / 2-CO ₂ / 3-PRE / 4-SEN (other sensor)
		186	SE2 Sensor selection	1	rw	-	[0,4]	0	0-"---" / 1-RH / 2-CO ₂ / 3-PRE / 4-SEN (other sensor)
		187	SR1 RF Sensor selection	1	rw	-	[0,2]	0	0-"---" / 1-RH / 2-CO ₂
		188	SR2 RF Sensor selection	1	rw	-	[0,2]	0	0-"---" / 1-RH / 2-CO ₂
		190	PID function status	1	rw	-	[0,1]	0	0-Passive / 1-32000 PID reference value
		191	PID Timer Ref	1	rw	ms	[0,32000]	1000	
		192	PID KP	1	rw	-	[0,4]	0	
		193	PID Ti	1	rw	-	[0,4]	0	
		194	PID Td	1	rw	-	[0,4]	0	
		196	Working time count for filter-1	1	rw	h	[0,6000]	-	
		197	Unit latest status info	1	r	-	[0,1]	0	When unit power on, it starts working from this situation
		198	DX system fault count	1	rw	pcs	-	0	
		199	Working time count for filter-2	1	rw	h	[0,6000]	-	
		200	Working time count for ultraviolet lamp	1	rw	h	[0,6000]	-	



Aidelle House, Lancaster Road, Cressex Business Park,
High Wycombe, Buckinghamshire,
HP12 3QP, United Kingdom

Product Security and Telecommunications Infrastructure Statement of Compliance

Airflow Developments Ltd, herewith declare that the air movement equipment designated below, on the basis of its design and construction in the form brought onto the market by us in accordance with the relevant requirements of the UK Product Security and Telecommunications Infrastructure (Product Security) regime.

Designation of Equipment: Airflow Ventilation Equipment

Series / Type:

- Adroit with Cloud Connectivity functionality Series
- Entro-V with Modbus Series
- Duplexvent AHU Units Series (Multi, Multi V, Multi N Rooftop, Multi Eco, Multi Eco V, Multi Eco N Rooftop, Rotary, Rotary N Rooftop, Flexi, DUPLEXhome PS, DUPLEXhome PT, DUPLEXbase PS, DUPLEXbase PT) with RD5 or RD6 Control System
- iCONsmart

Applied Legislations:

PSTI Act 2022	Part 1 of the Product Security and Telecommunications Infrastructure
Security Requirements for Relevant Connectable Products Regulations 2023	The Product Security and Telecommunications Infrastructure

The requirements are based on three of the original guidelines in the 2018 Code of Practice, and provisions in ETSI EN 303 645, on a statutory footing.

The minimum time that Airflow provides security updates for is 2 years from the date of installation/commissioning.

Information on how to report security issues related to the products listed above: please contact Airflow on the telephone number shown below and describe the security issues encountered.

Any alterations or modifications made to the equipment, without prior consultation with Airflow Developments Ltd, invalidates this declaration.

Signed:

Date: 28/03/2024

Name: Alan Siggins

Position: Managing Director

Telephone: (Int +44) (UK 0) 1494 525252; Fax: (Int +44) (UK 0) 1494 461073
E-mail: info@airflow.com; Website: www.airflow.com

Form No:- 080
Issue:- 002
Date Revised:- 09/06/2013





©Copyright 2016. Airflow Developments Ltd

Airflow Developments Limited

Aidelle House, Lancaster Road, Cressex
Business Park, High Wycombe
Buckinghamshire, HP12 3QP, U.K

E: info@airflow.com

T: 44(0)1494 525252

W: airflow.com

